

Mini-PLC STG-500

Art. No. 0850-0500

MANUAL

4 PRODUCT DESCRIPTION2

4.1 Features2

4.2 Applications2

4.3 General description2

4.4 Programming with miCon-L3

4.5 Delivery content3



TABLE OF CONTENT

1 SAFETY INSTRUCTIONS2

2 DESTINATED USE2

3 DISCLAIMER2

5 INSTALLATION3 5.1

Mounting3

5.2 Wiring3

5.2.2 Connecting the power supply4

5.2.3 Connecting the inputs4

5.2.4 Connecting the outputs4

6 OPERATION AND PROGRAMMING5

7 APPENDIX6 7.1

Specifications6 7.1.1

General6

7.1.2 Power supply6

7.1.3 Inputs6

7.1.4 Outputs7

7.1.5 Electrical connection7

7.1.6 Electromagnetic compatibility (EMC)7

7.1.7 Security features7

7.1.8 Program and data memory7

7.1.9 Environmental conditions7

7.1.10 Weight and dimensions7

7.1.11 Ordering information7 **7.2 Disposal**

.....8

7.3 Conformity declaration8

7.4 Documents, videos and software8

1 SAFETY INSTRUCTIONS

This manual contains notices which you should observe to ensure your own personal safety, as well as to protect the product and the connected equipment. These notices are highlighted in the manual by a warning symbol and are marked as follows according to the level of danger:



Only qualified personnel should be allowed to install and work on this equipment. Qualified persons are defined as persons who are authorized to commission, to ground and to tag circuits, equipment and systems in accordance with established safety practices and standards.



Turn off the power supply before performing any wiring operations! Short circuits can be harmful, critical and can cause explosions and serious burns!



Please read this manual carefully and observe all safety instructions!

2 DESTINATED USE

The Mini-PLC is designed for universal measuring, controlling and regulating applications. It must not be used for life critical, medical or fail safe applications.

3 DISCLAIMER

BARTH Elektronik GmbH assumes no liability for usage and functionality of the Mini-PLC in case of disregarding this manual. The strict accordance of this manual is important since the installation methods, peripheral connections, usage and maintenance can not be controlled by BARTH Elektronik GmbH. Therefore BARTH Elektronik GmbH assumes no liability for any claim.

4 PRODUCT DESCRIPTION

The picture below shows the BARTH® Mini-PLC STG-500 with additional accessory, included in the STA-500 StarterKit (Art. No. 0660-0500). The STG-500 (Art. No. 0850-0500) comes without RS-232 connection cable VK-10.



4.1 Features

- Small and universal Programmable Logic Controller (PLC)
- 3 analog/digital inputs 0..30 VDC
- 2 digital inputs up to 10 kHz
- 4 power outputs up to 1.5 A
- 1 power PWM output 2 A/0..10 kHz

- Reliable solid-state outputs
- Programmable Status LED
- Reliable RS-232 connection to PC
- Intuitive graphical programming capability
- Wide operating voltage range 7..32 VDC
- Wide operating temp. range -40..+60°C
- Vibration resistant and rugged PU sealing
- Very low current consumption

4.2 Applications

- Industrial Automation
- Building Automation
- Automotive Technology
- Agriculture Vehicles
- Maritime Technology
- Environmental Technology
- Light and Show Technology

4.3 General description

The STG-500 is a highly integrated programmable logic controller (PLC) providing outstanding graphical programming capability at lowest current consumption and small form factor.

With it's cutting edge features the STG-500 opens up completely new application fields with space restrictions and high integration level requirements.

The STG-500 does not need any peripheral components to operate. Both inputs and outputs features highly integrated and rugged protection circuits to operate the Mini-PLC in harsh environment. Due to it's extremely low current consumption and wide operation voltage range the STG-500 is well suitable for 12 and 24 V battery-powered systems. These outstanding features open up a variety of application fields in industrial, automotive and maritime technology. The STG-500 is also available as customer-tailored OEM version.

4.4 Programming with miCon-L

Without learning a difficult programming language the BARTH® Mini-PLC can be easily programmed using simple and vivid graphical function blocks. This block design meets graphical standards of the latest graphical programming languages.

The miCon-L software suite features programming, simulation and test in one unique software design tool. The flexible programming option offers a variety of possibilities in industrial, automotive and maritime applications.

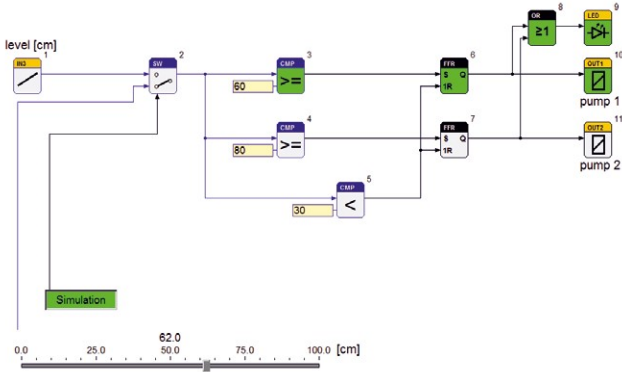

Programming the Mini-PLC follows using the RS-232 port of your PC with installed miCon-L software suite. In case your PC is not equipped with an RS-232 interface you have to use an USB/RS232-Adapter (BARTH Art. No. 0208-0012). miCon-L also supports full simulation and visualisation operation modes. The software provides a variety of visualisation blocks and interactive elements to control and debug the Mini-PLC.

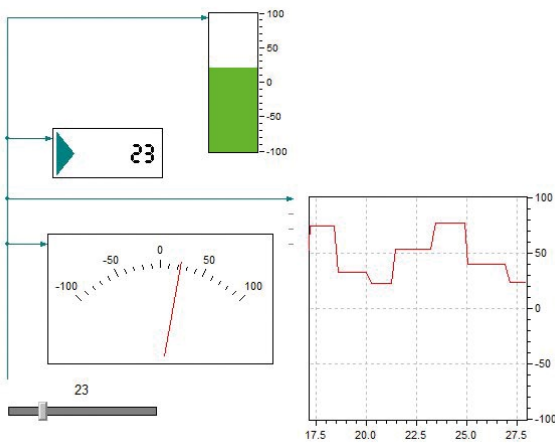

For detailed information please read the BARTH® miCon-L manual and the BARTH® Application Notes on: www.barth-elektronik.de

4.5 Delivery content

- BARTH® Mini-PLC STG-500
- Spring terminal connectors (for supply, input/output)
- Quick start manual

5 INSTALLATION

5.1 Mounting



The Mini-PLC must be installed and wired by a trained technician who knows and complies with both the universally applicable engineering rules and the regulations and standards that apply in specific cases.

Fastening the STG-500 follows using either the integrated mounting holes for screws or the holes for cable ties. The cable tie installation method is recommended for fastening the STG-500 on wiring harness, tubes or other mechanical parts. **Take care to meet the environmental conditions of the STG-600 (chapter 7.1.9).**

5.2 Wiring

5.2.1 Overview

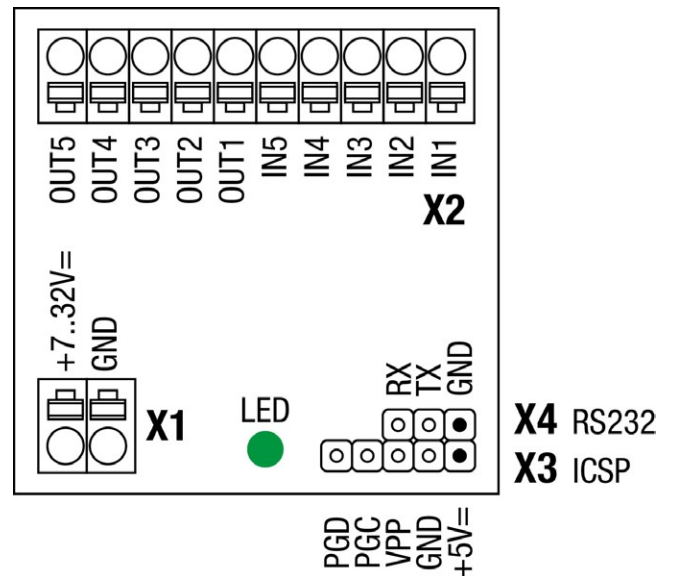

The X3 connector is reserved for factory programming (firmware update) only. It must not be used customer-used!



The X3 connector is ESD sensitive! Electrical stress may cause irreversible damage of the Mini-PLC!

5.2.2 Connecting the power supply

The STG-500 features an outstanding wide supply voltage range from 7 to 32 VDC at lowest current consumption. So the Mini-PLC can be integrated within battery supplied 12V or

 <p>BAR Elektronik GmbH®</p>	<p>Mini-PLC STG-500 Art. No. 0850-0500</p>	<p>MANUAL</p>	<p>Page: 4/9 Document: 9021-0002-A Date: 21.09.2015 Revision: A</p>
--	---	----------------------	---

24V DC systems (cars, trucks, battery powered cars, forklifts and digger, for example).



Turn off the power supply before performing any wiring operations!



False electrical connection, voltage reversal or disregarding the electrical specifications may cause irreversible damage of the Mini-PLC!

Connect the supply voltage of 7 to 32 VDC to the 2-pole terminal X1 of the STG-500. Wire the positive supply to the '+7..32V=' marked connection. The negative (ground) will be wired to the 'GND' connection. All terminals are carried out as plugable spring terminal connectors for a wire gauge of 0.25 to 1.5mm².



Ensure correct power supply voltage range and polarisation! External fusing of 5A max. is mandatory! Disregarding may cause irreversible damage of the PLC!

5.2.3 Connecting the inputs

You can connect sensors, switches or buttons to the inputs. The sensors may be temperature, flow, pressure, photoelectric sensors or proximity switches, for example. The STG-500 is well suitable for any sensor featuring a voltage output, 0 to 10 VDC, for example.

Common features of the inputs

- IN3 to IN5 are selectable analog/digital inputs
- IN1 and IN2 are pure digital inputs (up to 1kHz)
- Wide input voltage range 0 to 32VDC
- IN3 to IN5 are 0 to 10 V compatible
- Comprehensive integrated protection circuits
- Outstanding electromagnetic compatibility (EMC)
- Electrostatic discharge protection (ESD)

Due to the pull-down resistors integrated in the STG-500 any switch (NO/NC) can simply be connected between the

5.2.4 Connecting the outputs

Depending on load type and current the STG-500 is able to drive electric loads directly without any additional driver or protection circuit. The Mini-PLC provides 4 digital solidstate highside outputs and 1 solid-state lowside switch.

Common features of outputs OUT1 to OUT4

- Rugged solid-state highside switch up to 1.5A
- Paralleling permissible up to 4A
- Short circuit protection and current limitation
- Fast demagnetization of inductive loads
- Stable behaviour at undervoltage
- Comprehensive integrated protection circuits
- Outstanding electromagnetic compatibility (EMC)

- Electrostatic discharge protection (ESD)

Features of output OUT5

- Solid state lowside switch with PWM capability
- Sinks up to 2A
- Rugged solid-state design
- Fast demagnetization of inductive loads
- Outstanding electromagnetic compatibility (EMC)
- Electrostatic discharge protection (ESD)

The 10-pole connector X2 contains the digital outputs of the Mini-PLC. While OUT1 to OUT4 are overload-protected highside switches, OUT5 is carried out as lowside switch with PWM capability without short circuit protection. A logical HIGH within miConL will switch the Mini-PLC's supply voltage at OUT1 to OUT4, while OUT5 switches lowside (GND). Avoid a sink current exceeding 2A at OUT5 because this outputs is not protected against short-circuiting or overload current !



The total current sourced by OUT1 to OUT4 must not exceed 4A!
Avoid reverse voltage at any output higher than the Mini-PLC's supply voltage!
OUT5 provides NO short circuit protection.
Take care the sink current not exceeds 2A!
Negligence may cause irreversible damage of the Mini-PLC!

	Mini-PLC STG-500 Art. No. 0850-0500	MANUAL	Page: 5/9 Document: 9021-0002-A Date: 21.09.2015 Revision: A
---	--	---------------	---

Please refer to chapter 7.1.4 for detailed electrical specification of the outputs.

For choosing the correct COM-Port please click the right button (configure serial interface) located on the main menu

positive supply (VDD) of the STG-500 and the desired input.



The voltage at any input must not exceed 32VDC referred to ground (GND). Higher voltages or reverse voltage lower than -32VDC may cause irreversible damage of the Mini-PLC!

The 10-pole connector named X2 contains the inputs of the Mini-PLC. While IN1 and IN2 are pure digital inputs, IN3 to IN5 provide both digital or analog functionality. The voltage range for all inputs may not exceed 32 VDC. All inputs refer to GND. Please refer to chapter 7.1.3 for detailed electrical specification of the inputs.

6 OPERATION AND PROGRAMMING

To operate the STG-500 first establish proper power supply connection at both +VDD and GND terminals (see chapter 5.2.1).

For programming and PC connection the connection cable VK-10 (Art. No. 0091-0010) and a PC with installed Windows operating system are mandatory.



Before you connect the Mini-PLC to the PC you have to install the USB-/COM-port driver (folder ‚USBdriver‘) from the software download package: www.barth-elektronik.de/download/9045-0008-A.zip

Now install the miConL software suite from the ‚miCon-L‘ folder. Follow the setup instructions of miConL. Afterwards establish the PC connection using the VK-10 connection cable and run miConL.

page and confirm the added COM-Port used by the STG500.

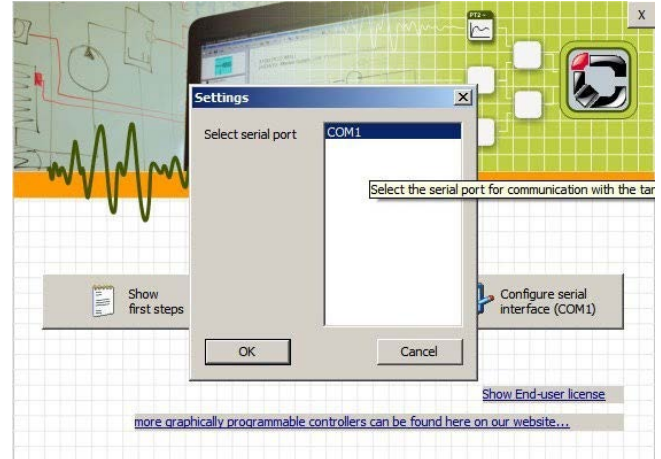

Now start miConL with creating a new project (Project-> New) or open a miCon-L sample application (Project>Open).

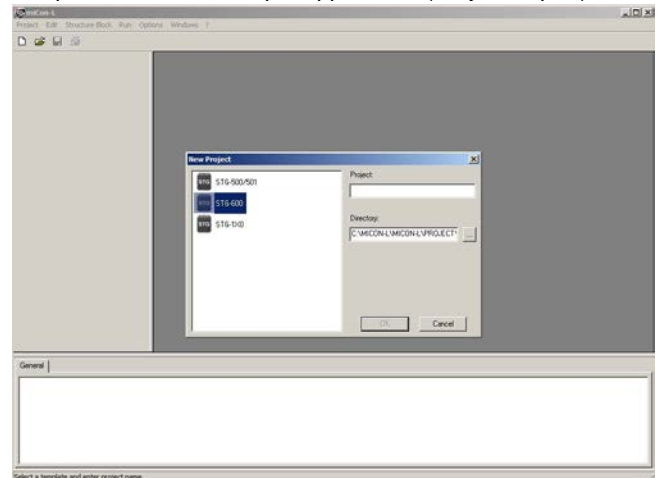

Creating a new project the desired Mini-PLC model and the project name have to be defined.

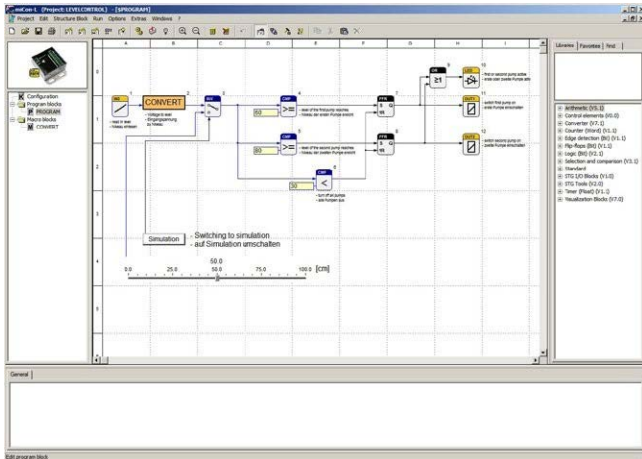

After opening or creating a project the workspace of miConL with its libraries (right) is shown.

7 APPENDIX

7.1 Specifications

7.1.1 General

7.1.2 Power supply

Operating voltage	7 to 32 VDC
Current consumption	< 4 mA at 32 VDC status LED switched off in application
Fusing	5 A max. (external) mandatory for voltage reversal protection
Voltage reversal protection	yes (combined with external fuse)
ESD/TVS protection	yes
Heat dissipation (at full load)	normally < 1.5 W

within

Hardware design	BARTH® Mini-PLC fully enclosed in proprietary PU resin, tiny and rugged housing with pluggable spring terminal connectors, ultra-lightweight
Programming	miCon-L Software, graphical (function block style), simulation, programming and visualisation, free license model
Interfaces	RS-232 reserved for miCon-L software communication

Additional help and a detailed user manual is provided
the miCon-L help and the miConL context menu (right
mouse button).

7.1.3 Inputs

Number digital	2+3
Number analog	3

Digital input IN1 - IN2	$U_{IN} = 0..30 \text{ VDC}$ $R_{IN} > 30 \text{ kOhm}$ $U_{LOW} \leq 2 \text{ VDC}$ $U_{HIGH} > 4 \text{ VDC}$ $f_{IN} \leq 1 \text{ kHz}$ $t_{IN} \geq 1 \text{ ms}$
Analog input IN3 - IN5	$U_{IN} = 0..30 \text{ VDC}$ $R_{IN} > 11 \text{ kOhm}$ $f_{IN} \leq 100 \text{ Hz}$ $t_{IN} \geq 1 \text{ ms}$
Accuracy ADC IN3 - IN5	$\pm 3\%$ (0.5 VDC)
ADC resolution (internal)	10 Bit
Potential isolation	no (common GND)
ESD/TVS protection	yes
Permissible cable length (per input)	normally 40 m

7.1.4 Outputs

Output OUT1 - OUT4	<p>Output type: solid state</p> <p>$I_{OUT} \leq 1,5 \text{ A}$ (resistive load) $f_{OUT} = 0..100 \text{ Hz}$ $U_{OUT} \geq U_{IN} - 0,45 \text{ V}$</p> <p>$I_{TOT} \leq 4 \text{ A}$ (paralleling permissible)</p> <p>Maximal allowable load inductance for a single switch off (one output): $V_{DD} = 12 \text{ VDC}, I_L = 1,5 \text{ A}, Z_L \leq 70 \text{ mH}$ $V_{DD} = 12 \text{ VDC}, I_L = 1 \text{ A}, Z_L \leq 200 \text{ mH}$</p> <p>On-state resistance V_{DD} to OUT: $R_{ON} \leq 180 \text{ mOhm}$</p> <p>Turn-on time: $t_{ON} \leq 250 \mu\text{s}$ Turn-off time: $t_{OFF} \leq 270 \mu\text{s}$</p>
PWM output OUT5	<p>Output type: solid state</p> <p>$I_{OUT} \leq 2 \text{ A}$ (resistive load) $f_{OUT} = 0..100 \text{ Hz}$ $I_{OUT} \leq 1 \text{ A}$ (resistive load) $f_{OUT} = 100 \text{ Hz}..5 \text{ kHz}$ $U_{OUT} \leq GND + 0,25 \text{ V}$</p>
Potential isolation	no

Flash program memory	k cell endurance: 10.000 min characteristic retention: 40 yrs
EEPROM data memory	byte endurance 100.000 min. characteristic retention: 40 yrs
Number digital	4+1
Number PWM	1

7.1.5 Electrical connection

Electrical Connection	pluggable spring terminal connectors 0.25 to 1.5 mm ²
------------------------------	--

BAR

Elektronik

GmbH **H**®**Mini-PLC
STG-500
Art. No. 0850-0500****MANUAL**Page: 8/9
Document: 9021-0002-A
Date: 21.09.2015
Revision: A

7.1.6 Electromagnetic compatibility (EMC)

Electrostatic discharge (ESD) on IN1 to IN5	20 kV air discharge 30 kV contact discharge (IEC/EN 61 000-4-2, level 3)
Electrostatic discharge (ESD) on OUT1 to OUT5	8 kV (human body model) (MIL-STD883D)
Electromagnetic fields	Field strength 10 V/m (IEC/EN 61000-4-3)

7.1.11 Ordering information

7.1.7 Security features

Security Features	Watchdog (WD) Brown out detection (BOD) Power up timer (PUT)
--------------------------	--



7.1.8 Program and data memory

7.1.9 Environmental conditions

Operation temperature	-40..+60 °C (IEC 60068-2-1/2)
Storage temperature	-40..+70 °C (IEC 60068-2-1/2)
Relative humidity	to 95% non-condensing (IEC 60068-2-30)
Air pressure (in operation)	to 1500 hPa
Shock resistance	min. 100 m/s ² (IEC 60068-2-27)
Vibration resistance	min. 50 m/s ² @ 10..150 Hz (IEC 60068-2-6)
Degree of protection	IP 20, limited by connectors (EN 50178, IEC 60529)
Drop	Drop height: 500mm (IEC 60068-2-31)
Free fall (packaged)	mm (IEC 60068-2-32)
Weight	g (without connectors)
Dimensions	x 40 x 22 mm (LxWxH)
Mounting	via two M4 screws or 3.6mm cable ties

7.1.10 Weight and dimensions

Ordering information Mini-PLC	Mini-PLC STG-500 Art. No. 0850-0500
Ordering information Starter-Kit	Starter-Kit STA-500 Art. No. 0660-0500
Ordering information accessory	USB connection cable VK-10 Art. No. 0091-0010 Adapter RS-232 <-> USB Art. No. 0208-0012

 BAR Elektronik  GmbH	Mini-PLC STG-500 Art. No. 0850-0500	MANUAL	Page: 9/9 Document: 9021-0002-A Date: 21.09.2015 Revision: A
--	--	---------------	---

7.2 Disposal



If you wish to finally dispose of the product, ask your local recycling centre or dealer for details about how to do this in accordance with the applicable disposal regulations.

7.3 Conformity declaration

For the following designated product it is hereby confirmed, that the construction in that technical design brought by us in traffic corresponds to the standards specified below. In the event of any alternation which has not been approved by us being made to any device as designated below, this statement shall thereby be made invalid.

Description	Mini-PLC
Type	STG-500
Art. No.	0850-0500
Directive 2004/108/EG relating to electromagnetic compatibility (EMC) 	Applied norms: EN55022:2006+A1:2007 EN55024:1998+A1:2001 +A2:2003 EN61000-3-2:2006 +A1:2009+A2:2009 EN61000-3-3:2008 EN61000-6-2:2005
RoHS Directive 2011/65EU	We hereby declare that our product is compliant to the RoHS Directive on restriction of the use of certain hazardous substances in electrical and electronic appliances.

BARTH® Elektronik GmbH

Lengerich, 10.10.2013

D. Barth

Dipl.-Ing. (FH) D. Barth
Managing Director

7.4 Documents, videos and software

Detailed information, additional documents, application notes and videos relating to this product are downloadable from www.barth-elektronik.de