

Characteristics / Ordering Code

Throttle check valves series ZRD are designed for maximum flow rates.

The throttle check function can be located in port A or B as well as in A + B. Meter-in or meter-out functionality can be selected by model code.

A low flow / high resolution version in NG06 for sensitive shifting time adjustment of pilot operated directional control valves is available on request.

Features

- High flow capacity
- Various functional arrangements
- ZRD01 - NG06 (CETOP 03)
ZRD02 - NG10 (CETOP 05)



ZRD-ABZ01

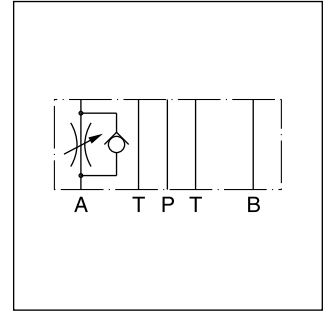

ZRD-AA02

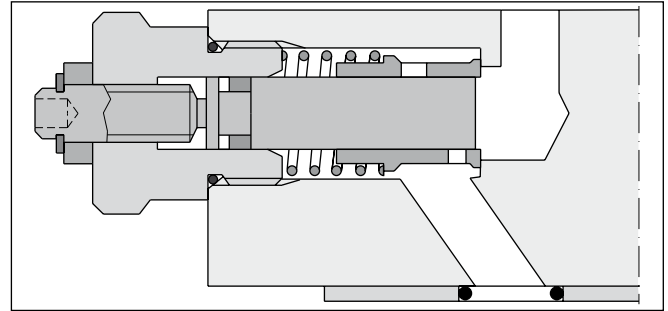

ZRD-AA02

Ordering code

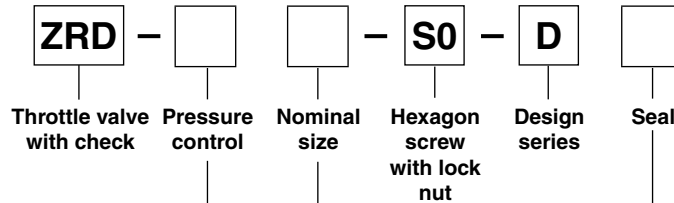

Code	Pressure control
AA	Meter-out control in A
AZ	Meter-in control in A
BA	Meter-out control in B
BZ	Meter-in control in B
ABA	Meter-out control in A and B
ABZ	Meter-in control in A and B

Code	Seal
1	NBR
5	FPM

Code	Nominal size
01	NG06
02	NG10

Ordering code details see end of chapter.

Technical data

General			
Size		NG06	NG10
Mounting interface		DIN 24340 A6 ISO 4401 NFFPA D03	DIN 24340 A10 ISO 4401 NFFPA D05
		CETOP RP 121	
Mounting position		unrestricted	
Ambient temperature	[°C]	-20...+50	
MTTF _D value	[years]	150	
Weight	1 cartridge [kg]	1.2	2.8
	2 cartridges [kg]	1.3	2.9
Hydraulic			
Max. operating pressure	[bar]	350	315
Nominal flow	[cSt] / [l/min]	80	160
Leakage	[cSt] / [l/min]	0.1...0.2 (at closed throttle)	0.1...0.2 (at closed throttle)
Opening pressure	[bar]	0.7	0.7
Fluid		Hydraulic oil according to DIN 51524...51525	
Fluid temperature	[°C]	-20...+80	
Viscosity	permitted [cSt] / [mm ² /s]	10...650	
	recommended [cSt] / [mm ² /s]	30	
Filtration		ISO 4406 (1999); 18/16/13	

p/Q performance curves

ZRD*01

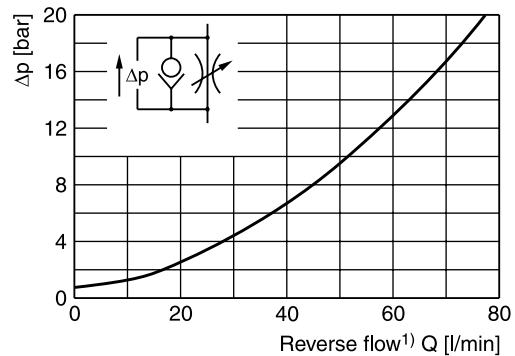
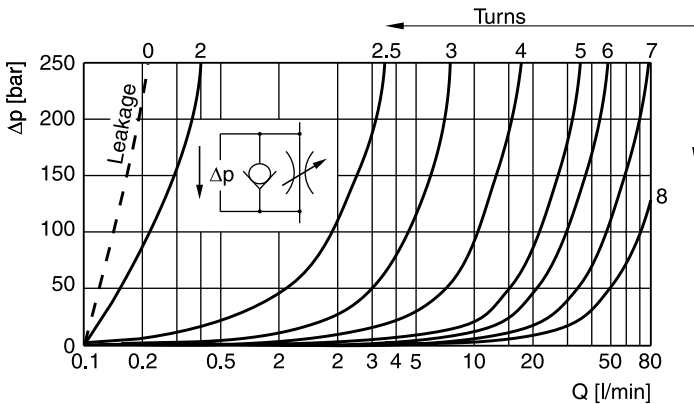

ZRD*02

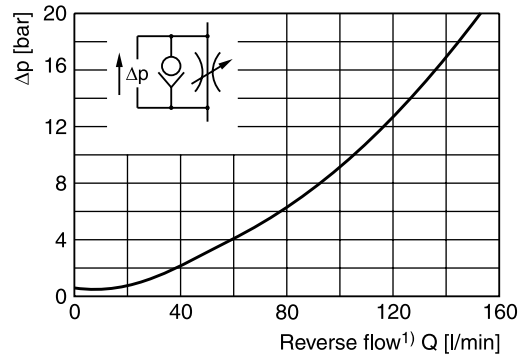
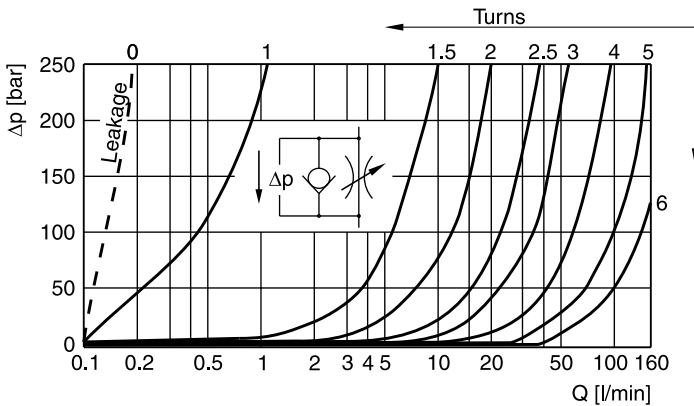

¹⁾ Throttle closed.

All characteristic curves measured with HLP46 at 50 °C.

Dimensions

ZRD*01

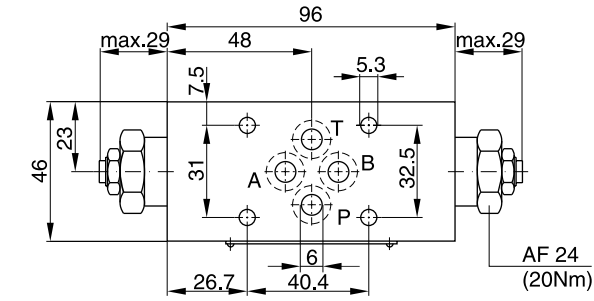

Seal kit	
Seal	Order code
1	098-91096-0
5	098-91097-0
Complete cartridge	
Order code 098-91119-0	
O-ring plate	
Order code S26-27553-0	

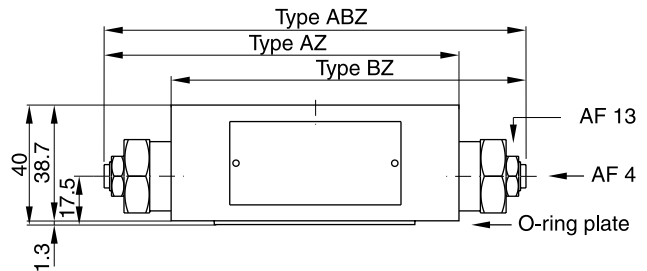
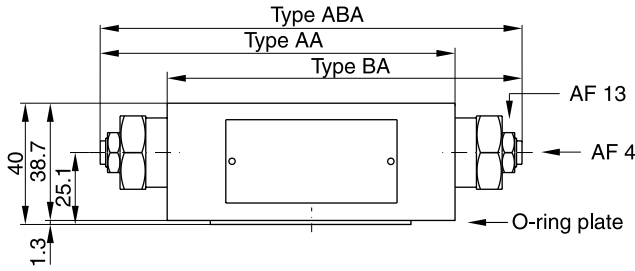

ZRD*02

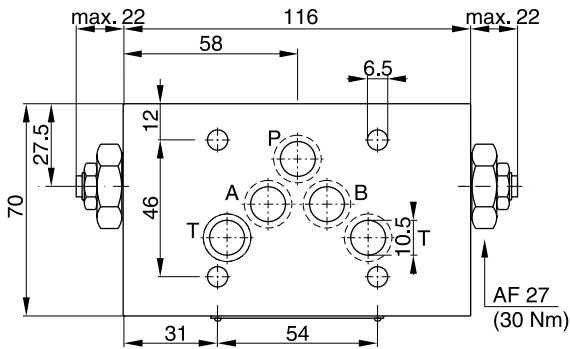

Seal kit	
Seal	Order code
1	098-91098-0
5	098-91099-0
Complete cartridge	
Order code 098-91120-0	
O-ring plate	
Order code S16-85742-0	

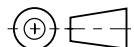
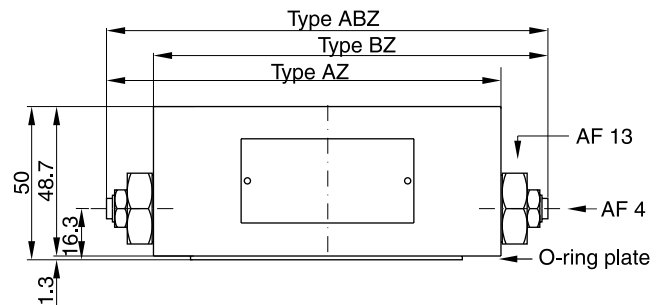
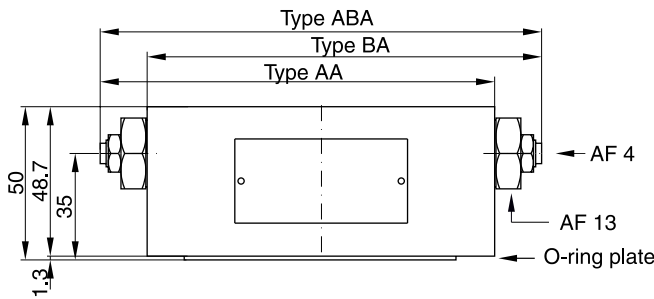

ZRD*01

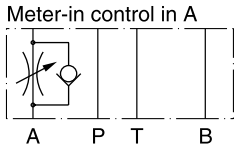

Series
 ZRD-AZ01-S0-D1

Order No.
 098-91056-0

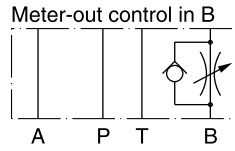

Series
 ZRD-BA01-S0-D1

Order No.
 098-91013-0

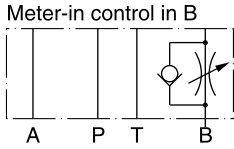

Series
 ZRD-BZ01-S0-D1

Order No.
 098-91057-0

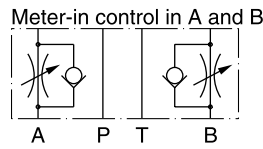

Series
 ZRD-ABZ01-S0-D1

Order No.
 098-91058-0

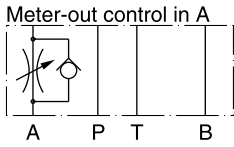

Series
 ZRD-AA01-S0-D1

Order No.
 098-91012-0

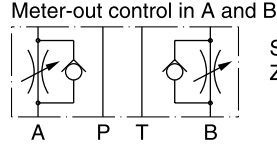

Series
 ZRD-ABA01-S0-D1

Order No.
 098-91014-0

ZRD*02

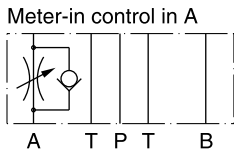

Series
 ZRD-AZ02-S0-D1

Order No.
 098-91059-0

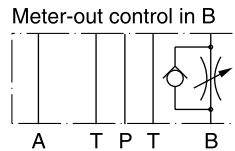

Series
 ZRD-BA02-S0-D1

Order no.
 098-91016-0

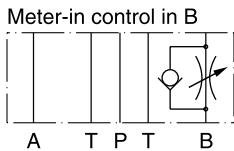

Series
 ZRD-BZ02-S0-D1

Order No.
 098-91060-0

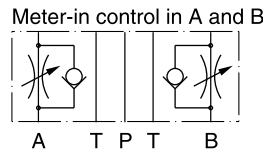

Series
 ZRD-ABZ02-S0-D1

Order no.
 098-91061-0

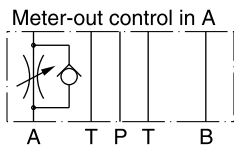

Series
 ZRD-AA02-S0-D1

Order no.
 098-91015-0

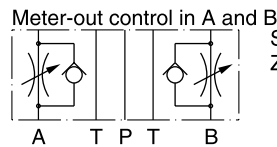

Series
 ZRD-ABA02-S0-D1

Order no.
 098-91017-0

7