

Montageausschnitt
panel cut out

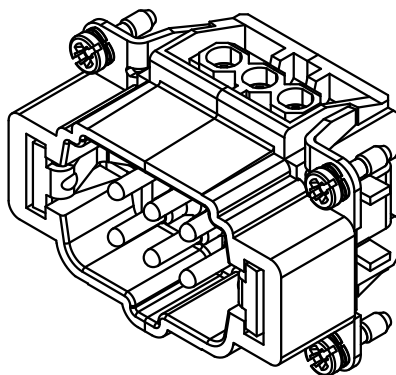
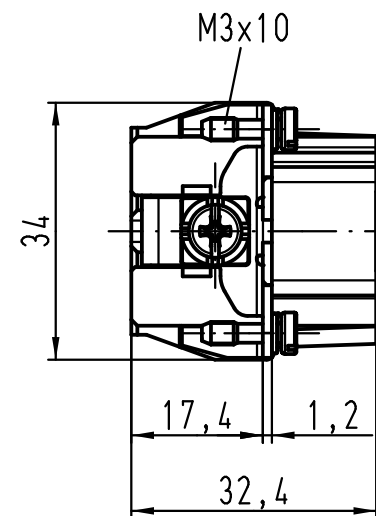
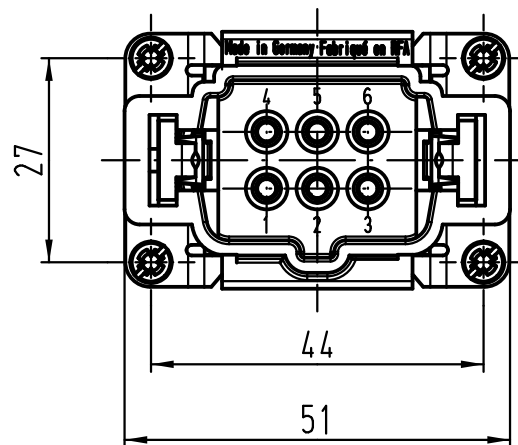
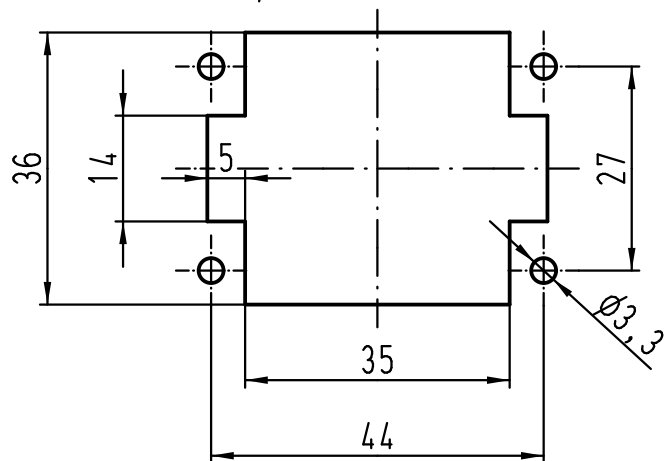

All Dimensions in mm Original Size DIN A 4		Techn. Character.			Nicht tolerierte Maße/Free size tolerances	
			Dat.	Name	Maßstab/Scale 1:1	Han 6E-M-s Stifteinsatz male insert
		Detail.	02.09.11	Spr		
		Insp.		Tie		
		Stand.				
A		HARTING Electric GmbH & Co. KG				TB 09 33 006 2601
Mod.	Dat.	Name	D-32339 Espelkamp			
					Sub. TB 09 33 006 2601 v. 09.04.98	
						Blatt/ page