

Lighted PushButton Switch

A3D

Cylindrical 8mm dia. Subminiature Series Featuring Short Mounting Depth

- Round, square and rectangular LED pushbutton units.
- Indicator types also available.
- Requires only 18mm mounting depth.
- Efficiency in wiring improved by terminals arranged on the same level.
- All LEDs, lamps, lenses and legends replaceable without tools.
- Degree of protection conforms to IP40.

Ordering Information

Illuminated types

When placing your order, specify the individual component part numbers of the pushbutton unit, LED, lamp and switch unit, as listed in the ordering tables below.

Pushbutton Unit



A3D- -500-
M2D- -500- *

* Model number unique for indicator unit

Switch Unit



A3D- -7- - -
M2D- -7- - - *

* Model number unique for indicator unit

Pushbutton Unit Lighted type, Built-in LED

Shape	Rectangular	Square	Round
Button colour			
Red	A3DJ-500R	A3DA-500R	A3DT-500R
Yellow	A3DJ-500Y	A3DA-500Y	A3DT-500Y
Green	A3DJ-500GY	A3DA-500GY	A3DT-500GY
White	A3DJ-500W	A3DA-500W	A3DT-500W

Indicator

Shape	Rectangular	Square	Round
Button colour			
Red	M2DJ-500R	M2DA-500R	M2DT-500R
Yellow	M2DJ-500Y	M2DA-500Y	M2DT-500Y
Green	M2DJ-500GY	M2DA-500GY	M2DT-500GY
White	M2DJ-500W	M2DA-500W	M2DT-500W

Switch Unit

Degree of protection			IP40		
Appearance			Rectangular	Square	Round
Contact configuration	Switch action	Terminal			
			SPST-NO+ SPST-NC	Momentary	Solder
For Indication (without switch)	Alternate	PCB	A3DJ-7112	A3DA-7112	A3DT-7112
		Solder	A3DJ-7121	A3DA-7121	A3DT-7121
	PCB	A3DJ-7122	A3DA-7122	A3DT-7122	
		Solder	M2DJ-7001	M2DA-7001	M2DT-7001
		PCB	M2DJ-7002	M2DA-7002	M2DT-7002

Specifications

■ Contact Ratings

DC (Resistive load)	0.1A, 30VDC
---------------------	-------------

Note: The minimum permissible load is 1mA, 5VDC

■ Built-in LED Ratings

Item	LED colour	Red	Yellow	Green
Forward voltage V_F	Standard value*	1.7V	2.2V	1.7V
	Max. value	2.0V	2.5V	2.0V
Forward current I_F	Standard value*	20mA	20mA	20mA
	Absolute max. value	50mA	50mA	50mA
Permissible loss P_D	Absolute max. value	100mW	125mW	122mW
Reverse voltage V_R	Absolute max. value	4V	4V	4V

* Refer to V_F vs. I_F characteristics in Hints on Correct Use. Because no resistor is incorporated in the LED, connect an appropriate external resistance within the above limit.

■ Applicable load range

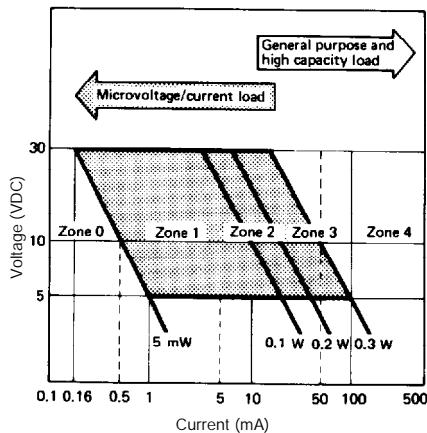

Note: The load range shown above is applicable only during the standard conditions.

■ Characteristics

Operating frequency	Mechanical	Momentary-action type: 120 operations per minute max. Alternate-action type: 60 operations per minute max.
	Electrical	20 operations/minute max.
Insulation resistance	100MΩ min. (at 500VDC)	
Dielectric strength	1,000VAC, 50/60Hz for 1 minute between terminals of same polarity 2,000VAC, 50/60Hz for 1 minute between terminals of different polarity and also between each terminal and ground	
Vibration	Malfunction	10 to 55Hz, 1.5mm double amplitude
Shock	Destruction	Approx. 500m/s ² (50G)
	Malfunction	Approx. 150m/s ² (15G)
Ambient temperature	Operating: -10_C to 55_C	
Humidity	35 to 85% RH	
Life expectancy	Mechanical	Momentary-action type: 1,000,000 operations min. Alternate-action type: 100,000 operations min.
	Electrical	100,000 operations min.
Weight	Approx. 3g	

■ Operating Characteristics

OF max.	250g
RF min.	20g
TT	3.5 ± 0.5mm
LTA min.	0.5mm
PT max.	2.5mm

Lighted Pushbuttons

Relays

Opto-Switches



Dimensions

Rectangular A3DJ/M2DJ

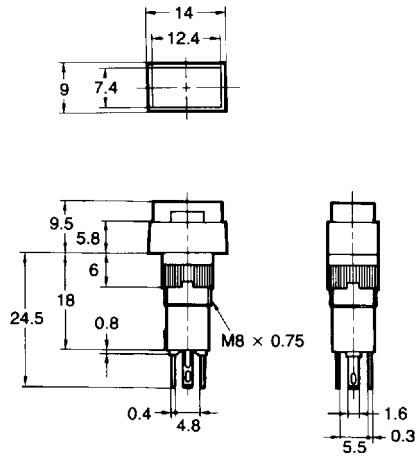
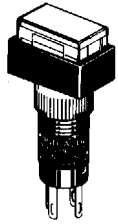

Panel cutout

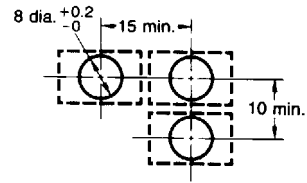

Square A3DA/M2DA

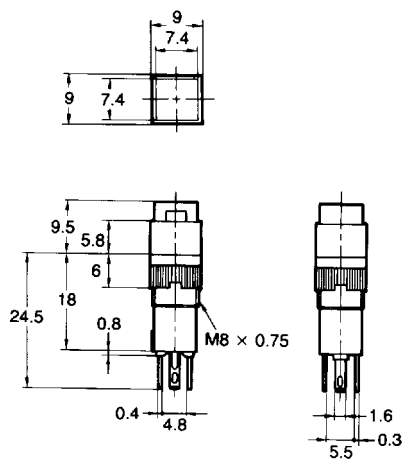

Panel cutout

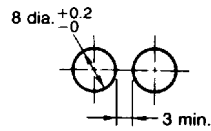

Round A3DT/M2DT

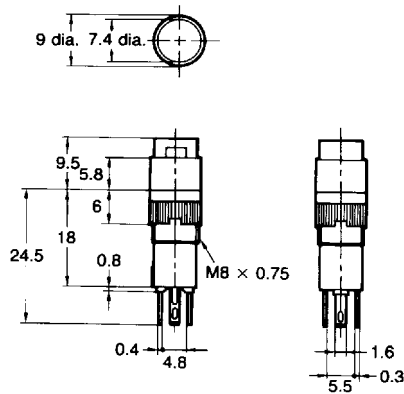

Panel cutout

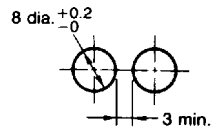

Legend plate

A3DJ

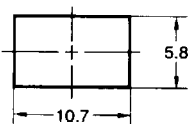

A3DA

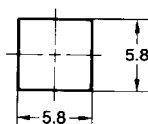

A3DT

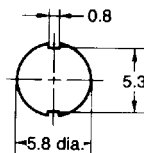

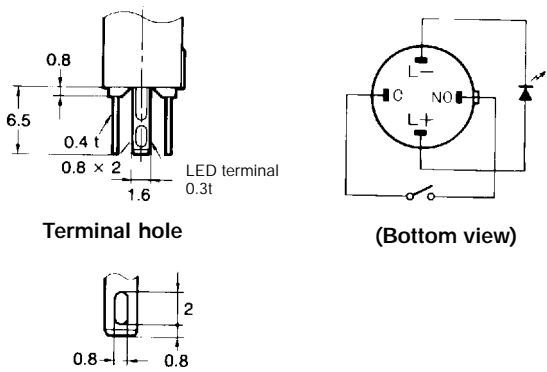
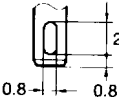
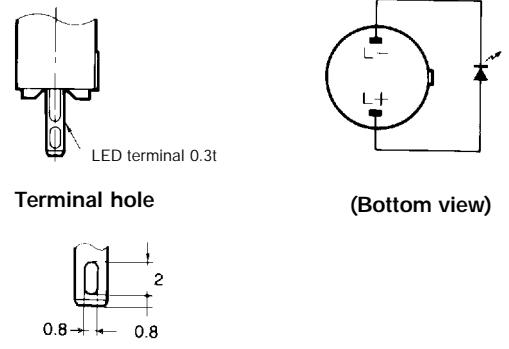
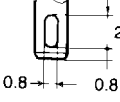
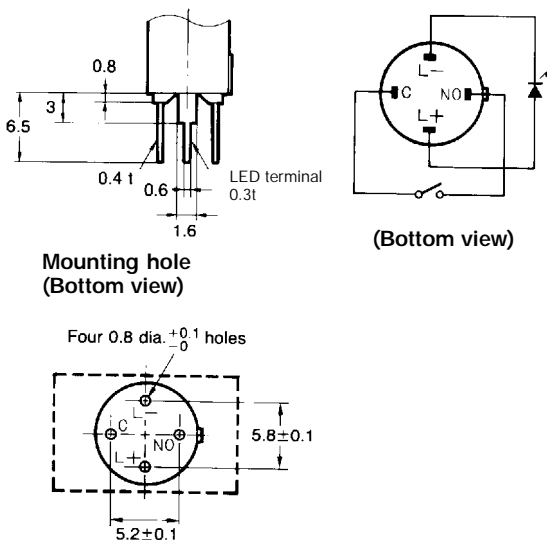
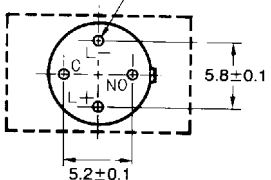
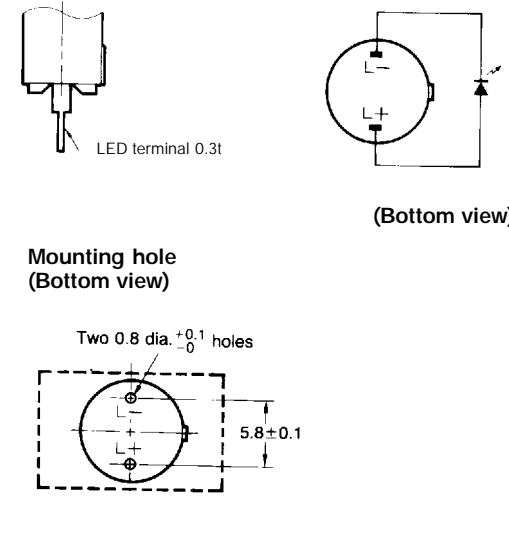
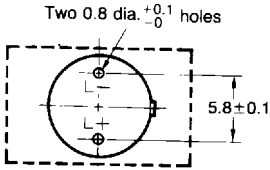

- Note:
1. The thickness is 0.8mm
 2. Since the legend plate is made of polycarbonate, use alcohol-based paints such as melanin, phthalic acid or acryl paint when marking the legend.

Terminals/Connections

Type Terminal	SPST-NO	Indicator
Solder Terminal	<p>Lighted type</p>  <p>Terminal hole</p> 	<p>Indicator</p>  <p>Terminal hole</p> 
PCB Terminal	<p>Lighted type</p>  <p>Mounting hole (Bottom view)</p>  <p>Four 0.8 dia. $\begin{smallmatrix} +0.1 \\ 0 \end{smallmatrix}$ holes</p>	<p>Indicator</p>  <p>Mounting hole (Bottom view)</p>  <p>Two 0.8 dia. $\begin{smallmatrix} +0.1 \\ 0 \end{smallmatrix}$ holes</p>

Accessories (Order Separately)

Name	Shape	Classification	Model	Remarks
Socket		Wire-wrap terminal	A3D-4101	Cannot be used with insulation cover
		PCB terminal	A3D-4102	
		Solder terminal	A3D-4103	
Tightening tool		-	A3D-3004	Useful for mounting switch units one after another. Do not over-tighten.



Assembly/Disassembly

Mounting directions for switch and pushbutton unit

1. Insert the pushbutton unit in the switch unit so that the circular shaped claw outside the projection of the switch unit mates with the claw on the upper part of the switch unit.
2. The pressure applied during the insertion should be 2.5kg max.

Note: If the LED terminal is bent, it may not align with the mating hole. Before insertion, check to see if any LED terminal is bent and, if so, straighten it. The inserting direction of the LED for the pushbutton unit is opposite to that for the indicator unit. Pay attention to the mounting direction of the legend plate.

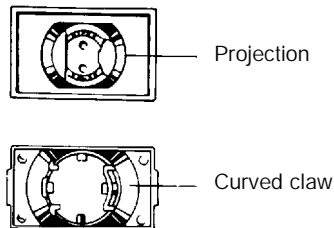

Removing the pushbutton unit

While holding the recessed portions on both sides, firmly and steadily pull out the top of the pushbutton unit with your thumb and forefinger. Pulling out the cap with pliers or a similar tool will damage the cap.

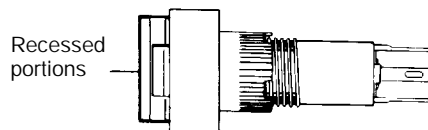

Mounting the switch unit on panel

Nut mounting

- Insert the switch unit from the front of the panel and tighten the mounting nut inserted from the rear of the panel.
- Since a projection exists on the rear portion of the switch unit, if the mounting unit cannot be fitted into position, turn the nut slightly.

- The tightening torque of the mounting nut should be less than 5kg-cm.
- Solder the terminals after mounting the nut. Otherwise, the terminals, when thickened by solder, may prevent the nut from being screwed down onto the switch unit.

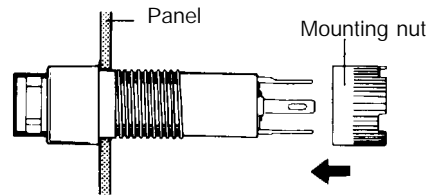

Construction

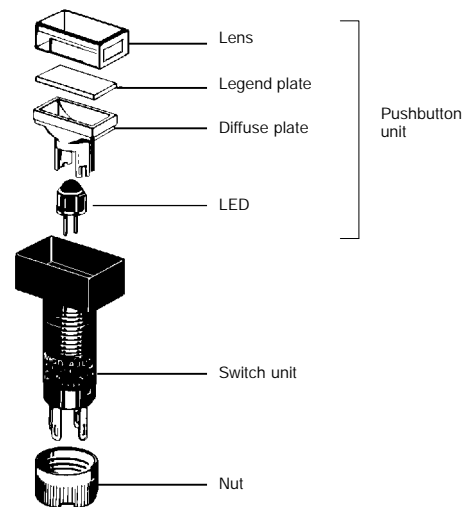

Wiring

- Finish soldering within 5 seconds with a 30 watt soldering iron, or within 3 seconds at a solder temperature of 240_C. To avoid deforming the softened plastic switch unit base, do not apply any force to the switch unit for about a minute after soldering.
- Use a non-corrosive, resin-based soldering flux.

Hints on Correct Use

LED

- Because no resistor is incorporated in the LED of the lighted pushbutton switch, connect an appropriate external resistor.
- Make sure that the resistance of the resistor is within the permissible range determined by the LED characteristics. The forward current of the LED must be 8mA minimum.
- The resistance of the external resistor can be obtained by this equation:

$$R = E - V_F / I_F (\Omega)$$

where,

E: operating voltage (V)

V_F: LED forward voltage (V)

I_F: LED forward current (mA)

Determine the resistance of the external resistor that satisfies the characteristics of the LED. However, the average LED forward current must be 8mA or more.

- Example of resistance calculation

When using a red LED where E=24V, I_F=20mA and T_a=25_C, from the V_Fs. I_F characteristics on the right, forward voltage V_F is 1.7V, when 20mA of I_F flows through the LED. Substituting these values for the variables in the above equation,

$$R = 24(V) - 1.7(V) / 0.02(A) = 1111(\Omega)$$

$$0.02(A) \text{ (or 20mA) (or 1.1k}\Omega)$$

Therefore, the estimated resistance is 1k Ω , 1W.