

Datasheet

Girder Threaded Rod Clamp M8, maximum load 60kg, 18mm

RS Stock number [2037622](#)

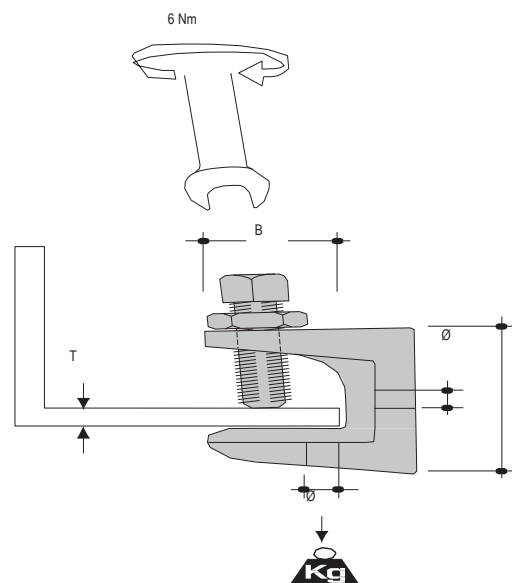
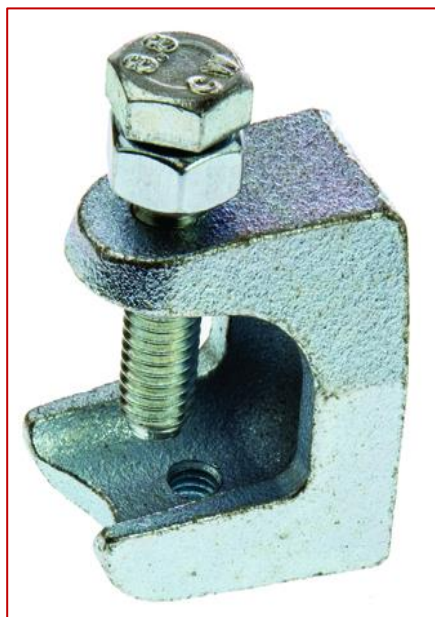

Description

Electroplated zinc finish, generally 8-12 microns thick with chromate coating, approximately 72 hours salt spray resistance ASTM-B117-90, DIN 50021, suitable for indoor, non-corrosive environments.

Specification

Flange Thickness	Maximum of 18mm
Flange Thickness Maximum	18mm
Material	Steel
Maximum Load	60kg
Thread Size	M8

Measurements

T	Maximum of 18mm
Ø	M8
A	40mm
B	20mm
C	60mm