

Datasheet

Sealed Lead-Acid Battery

General Purpose

537-5501(12V24Ah)

Specification

Cells Per Unit	6
Voltage Per Unit	12
Capacity	24.0Ah@20hr-rate to 1.80V per cell @25°C
Weight	Approx 7.20 kg
Max. Discharge Current	360 A(5 sec)
Internal Resistance	Approx 14mΩ
Operating Temp.Range	Discharge : -15~50°C (5~122°F) Charge : 0~40°C (32~104°F) Storage : -15~40°C (5~104°F)
Nominal Operating Temp. Range	25±3°C (77±5°F)
Float charging Voltage	13.5 to 13.8 VDC/unit Average at 25°C
Recommended Maximum Charging Current Limit	7.2A
Equalization and Cycle Service	14.4 to 15.0 VDC/unit Average at 25°C
Self Discharge	The batteries can be stored for more than 6 months at 25°C. Self-discharge ratio less than 3% per month at 25°C. Please charge batteries before using.
Terminal	T12
Container Material	A.B.S. (UL94-HB), Flammability resistance of UL94-V0 can be available upon request.

Applications

- ◆ All purpose
- ◆ Uninterruptable Power Supply (UPS)
- ◆ Electric Power System (EPS)
- ◆ Emergency backup power supply
- ◆ Emergency light
- ◆ Railway signal
- ◆ Aircraft signal
- ◆ Alarm and security system
- ◆ Electronic apparatus and equipment
- ◆ Communication power supply
- ◆ DC power supply
- ◆ Auto control system

Dimensions

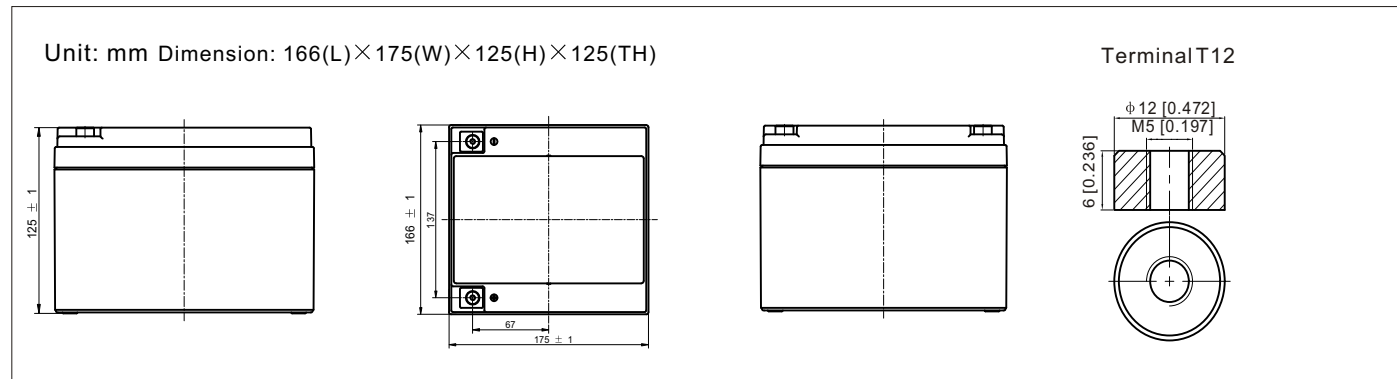

Constant Current Discharge Characteristics : A (25°C)

Amps

F.V/Time	5min	10min	15min	20min	30min	45min	1h	2h	3h	4h	5h	6h	8h	10h	20h
1.85V/cell	45.7	35.1	29.1	25.1	19.4	14.32	12.07	7.14	5.58	4.54	3.70	3.21	2.59	2.16	1.19
1.80V/cell	61.3	44.8	35.1	29.7	22.9	16.7	13.52	7.79	6.01	4.85	3.97	3.45	2.75	2.23	1.20
1.75V/cell	69.2	49.3	38.4	32.0	23.8	17.3	14.14	8.08	6.12	4.96	4.08	3.54	2.80	2.29	1.21
1.70V/cell	76.2	53.7	41.0	33.6	24.8	18.0	14.59	8.28	6.29	5.09	4.18	3.61	2.84	2.34	1.23
1.65V/cell	84.0	58.0	43.6	35.7	26.1	18.4	14.93	8.40	6.56	5.26	4.30	3.69	2.88	2.39	1.25
1.60V/cell	92.6	62.9	46.6	38.0	27.6	19.2	15.07	8.76	6.76	5.43	4.44	3.77	2.91	2.41	1.26

Constant Power Discharge Characteristics : W (25°C)

Watts

F.V/Time	5min	10min	15min	20min	30min	45min	1h	2h	3h	4h	5h	6h	8h	10h	20h
1.85V/cell	83.6	64.8	54.3	47.4	37.0	27.5	23.3	13.9	10.9	8.88	7.26	6.32	5.12	4.28	2.35
1.80V/cell	111.0	81.9	64.7	55.2	43.0	31.8	25.9	15.0	11.6	9.43	7.76	6.75	5.41	4.41	2.37
1.75V/cell	122.5	88.5	69.8	58.8	44.3	32.6	27.0	15.5	11.8	9.60	7.93	6.91	5.49	4.52	2.39
1.70V/cell	131.1	94.3	73.4	61.3	45.9	33.8	27.8	15.9	12.1	9.84	8.12	7.04	5.56	4.61	2.44
1.65V/cell	142.5	100.8	77.5	64.7	48.0	34.4	28.2	16.0	12.6	10.1	8.32	7.18	5.64	4.70	2.47
1.60V/cell	153.6	107.0	81.5	68.1	50.3	35.6	28.3	16.6	12.9	10.4	8.56	7.31	5.68	4.74	2.48

Effect of Temperature on Long Term Float Life

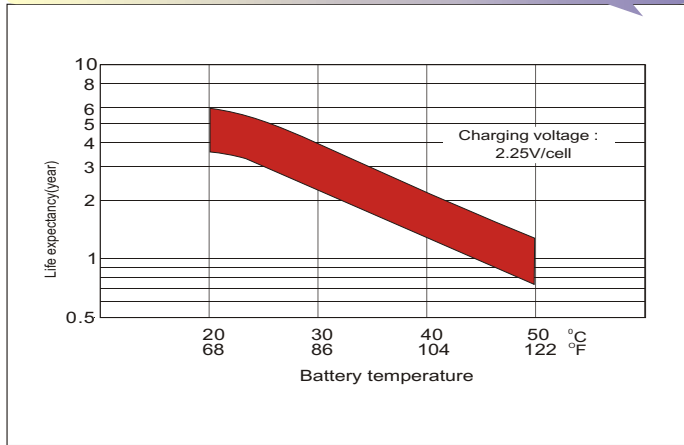

Self Discharge Characteristics

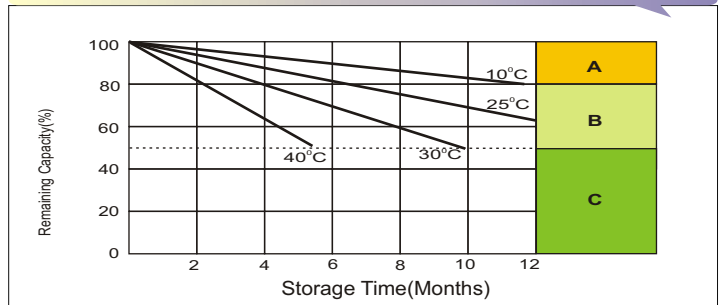

- A** No supplementary charge required (Carry out supplementary charge before use if 100% capacity is required.)
- B** Supplementary charge required before use. Optional charging way as below:
 1. Charged for above 3 days at limited current 0.25CA and constant voltage 2.25V/cell.
 2. Charged for above 20 hours at limited current 0.25CA and constant voltage 2.45V/cell.
 3. Charged for 8-10 hours at limited current 0.05CA.
- C** Avoid this storage period unless regular Top charge. Supplementary charge may often fail to recover the full capacity

Float Charging Characteristics

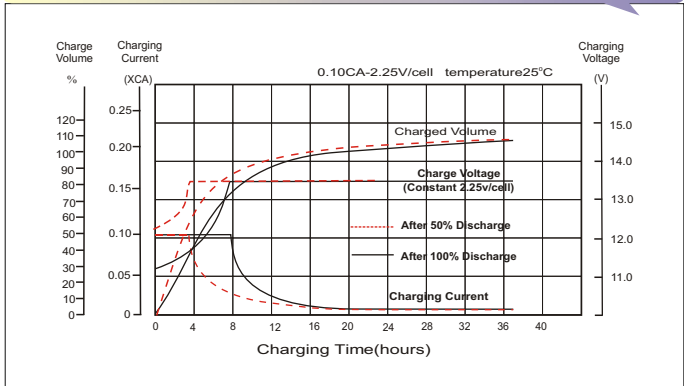

Discharge Characteristics

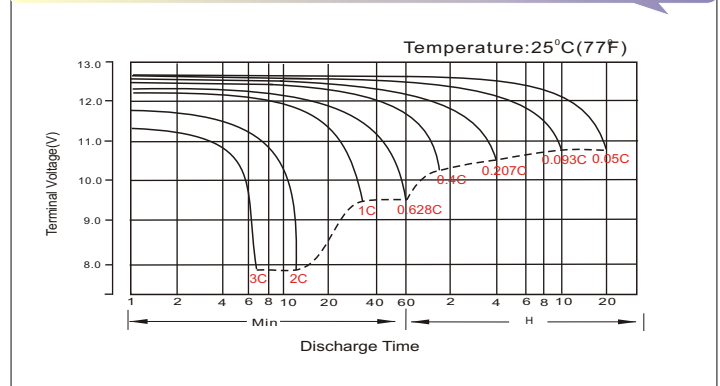

Available Capacity Subject to Temperature

Battery Type	-20°C	-10°C	0°C	5°C	10°C	20°C	25°C	30°C	40°C	45°C
AGM Battery 6V&12V	46%	66%	76%	83%	90%	98%	100%	103%	107%	109%

Discharge Current VS. Discharge Voltage

Final Discharge Voltage V/cell	1.80V	1.75V	1.60V
Discharge Current (A)	(A) ≤ 0.2C	0.2C < (A) < 1.0C	(A) ≥ 1.0C

Charge the batteries at least once every six months, if they are stored at 25°C.

Charging Method:

Constant Voltage	-0.2Cx2h+2.4~2.45V/Cellx24h, Max. Current 0.3CA
Constant Current	0.1C until the voltage reaching 14.4V, then 0.1Cx4h

Maintenance & Cautions

Float Service:
◆ It is recommended to check battery/Float voltage each month.
Equalisation charge:
◆ Equalisation charging is recommended once every 3 to 6 months using.
◆ Discharge 100% rated capacity.
◆ Charge 2.35v/cell constant voltage, maximum 0.3CA 24hrs.
Cyclic Service:
◆ Temperature compensation for varying temperatures:
-Charge voltage -3mV/Cell/degC from 25degC norm.
◆ The service life of your battery will be affected by:
-The number of discharge cycles, depth of discharge, ambient temperature and charging voltage.