

40 Watts

- Energy Efficiency Level VI
- CoC Tier 2
- Limited Power Source Approved
- <0.15 W Standby Power
- Optional Inlet Connector
- China Compulsory Certification (CCC) Qualified
- 0 °C to 65 °C Operation
- High Power Density
- Low Cost



Dimensions:

VEC40:

4.58 x 2.06 x 1.23" (116.3 x 52.4 x 31.3 mm)

Models & Ratings

Output Power	Output Voltage	Output Current	Total Regulation	Efficiency ⁽¹⁾	Model Number
40 W	12.0 V	3.33 A	±5%	89%	VEC40US12
	15.0 V	2.67 A		89%	VEC40US15
	24.0 V	1.67 A		89%	VEC40US24

Notes

1. Typical average of efficiencies measured at 25%, 50%, 75% and 100% load and 230 VAC input.

Mechanical Details

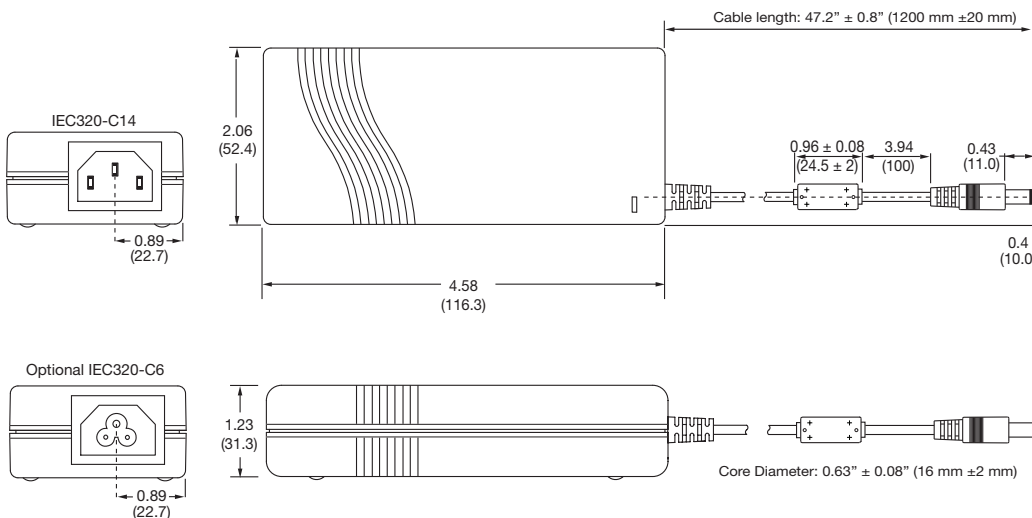

Power Cord for C14 inlet, Order

Part:

UK - UK-MAINS-IEC

European - EU-MAINS-IEC

US - US-MAINS-IEC

Power Cord for C6 inlet, Order Part:

UK - UK-MAINS-5

European - EU-MAINS-5

US - US-MAINS-5

Notes

1. All dimensions are shown in inches (mm), Tolerance is 0.04" (±1.0) max except output lead.

2. Weight: 0.52 lbs (240 g) approx.

3. Output connector is barrel type with 11 mm length, 5.5 mm dia. outer, 2.5 mm dia. inner with center + and outer shell - polarity.

Input

Characteristic	Minimum	Typical	Maximum	Units	Notes & Conditions
Input Voltage	90		264	VAC	
Input Frequency	47		63	Hz	
Input Current		0.8/0.6		A	Measured at 115/230 VAC
Inrush Current			70	A	230 VAC, cold start at 25 °C
Power Factor					EN61000-3-2 Class A
Earth Leakage Current			0.7	mA	264 VAC, 60 Hz
No Load Input Power			0.1	W	
Input Protection	T3.15A/250VAC internal fuse in line				

Output

Characteristic	Min.	Typ.	Max.	Units	Notes & Conditions
Output Voltage	12		24	VDC	See Models and Ratings table
Minimum Load					No minimum load required
Start Up Delay			3	s	
Start Up Rise Time		8		ms	
Hold Up Time	8			ms	Full load and 115 VAC
Line Regulation			±0.5	%	
Total Regulation			±5	%	Including initial set accuracy
Transient Response			4	%	Maximum deviation, recovering to less than 1% within 500 µs for 25% step load
Ripple and Noise			240	mV pk-pk	Measured with 20 MHz Bandwidth and 22 µF electrolytic in parallel with 0.1 µF ceramic capacitor.
Overshoot		5		%	At turn on / turn off
Overload Protection	110		170	%	
Overvoltage Protection		150		%	Recycle mains to reset
Short Circuit Protection	Trip and restart (hiccup), auto resetting				
Temperature Coefficient		±0.04		%/°C	

Environmental

Characteristic	Minimum	Typical	Maximum	Units	Notes & Conditions
Operating Temperature	0		+65	°C	Derate from 100% load at 45 °C to 50% load at 65 °C
Cooling	Natural convection				
Operating Humidity	5		90	%RH	Non-condensing
Storage Temperature	-20		+85	°C	
Operating Altitude			5000	m	
Shock	IEC68-2-27, 30 g, 11 ms half sine, 3 times in each of 6 axes				
Vibration	IEC68-2-6, 10-500 Hz, 2 g 10 mins/sweep, 60 mins for each of 3 axes				

Derating Curve

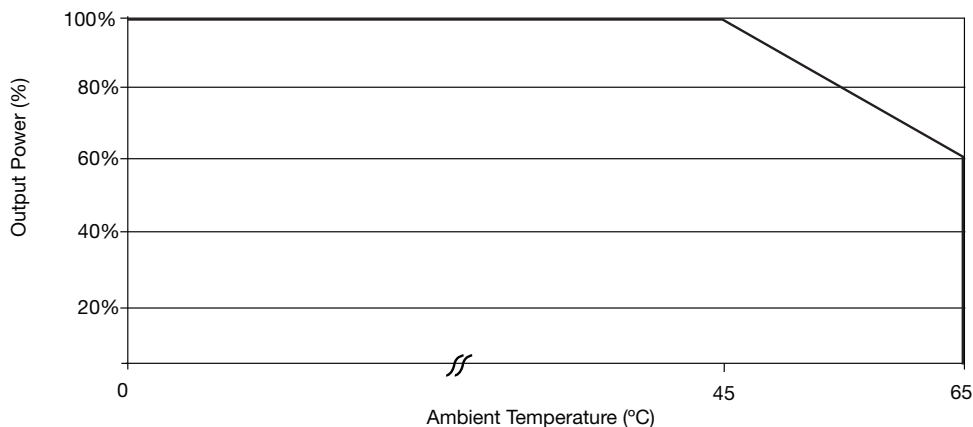

General

Characteristic	Minimum	Typical	Maximum	Units	Notes & Conditions
Efficiency		89		%	See Models and Ratings table and curves.
Isolation: Input to Output Input to Ground Output to Ground			3000	VAC	
			1500	VAC	
					Negative output is connected to ground
Switching Frequency		65		kHz	±10 kHz
Power Density			3.14	W/in ³	
Mean Time Between Failure		>200		kHrs	MIL-HDBK-217F at 25 °C GB
Weight		0.52 (240)		lb (g)	

Efficiency Curves

VEC40US12

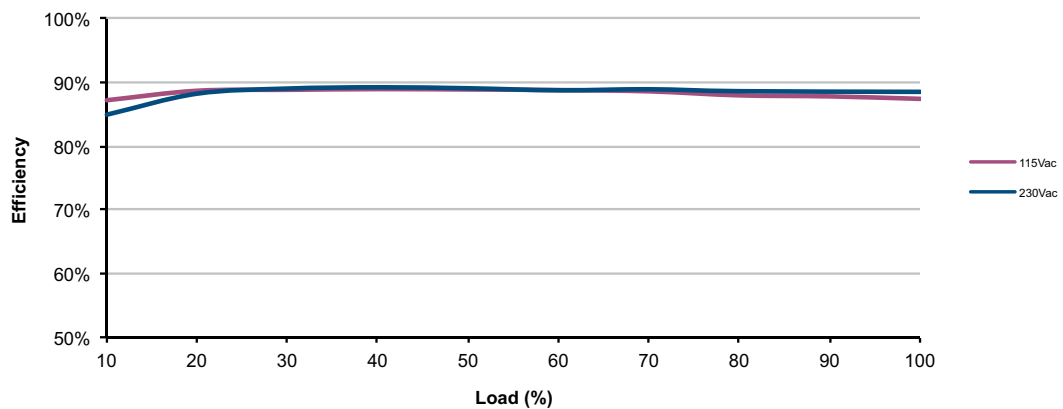

VEC40US24

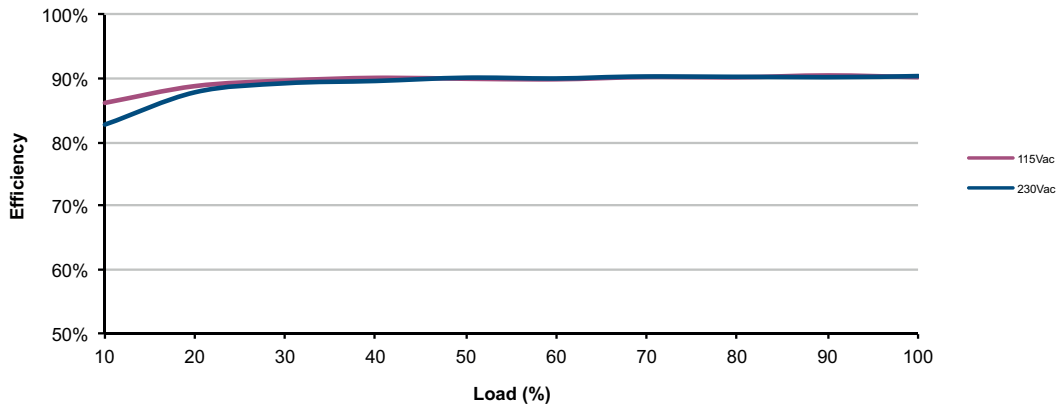

EMC: Emissions

Phenomenon	Standard	Test Level	Notes & Conditions
Emissions	EN55022	Level B	Conducted & Radiated
Harmonic Current	EN61000-3-2	Class A	
Voltage Flicker	EN61000-3-3		

EMC: Immunity

Phenomenon	Standard	Test Level	Criteria	Notes & Conditions
ESD	EN61000-4-2	±8 kV Air, ±4 kV contact	A	
Radiated	EN61000-4-3	3 V/m	A	
EFT/Burst	EN61000-4-4	3	A	
Surge	EN61000-4-5	Installation Class 3	A	
Conducted	EN61000-4-6	3 V	A	
Magnetic Fields	EN61000-4-8	3 A/m	A	
Dips and Interruptions	EN61000-4-11	Dip: 30% 500 ms	A/B	High Line/Low Line
		Dip: 60% 200 ms	A/B	High Line/Low Line
		Int: 100% 5000 ms	B	

Safety Approvals

Safety Agency	Safety Standard	Notes & Conditions
UL/CSA	cUL60950-1	Approved at Limited Power Source (LPS)
TUV	EN60950-1	
CB	IEC60950-1	
CCC	China Compulsory Certification (CCC)	

Mechanical Details

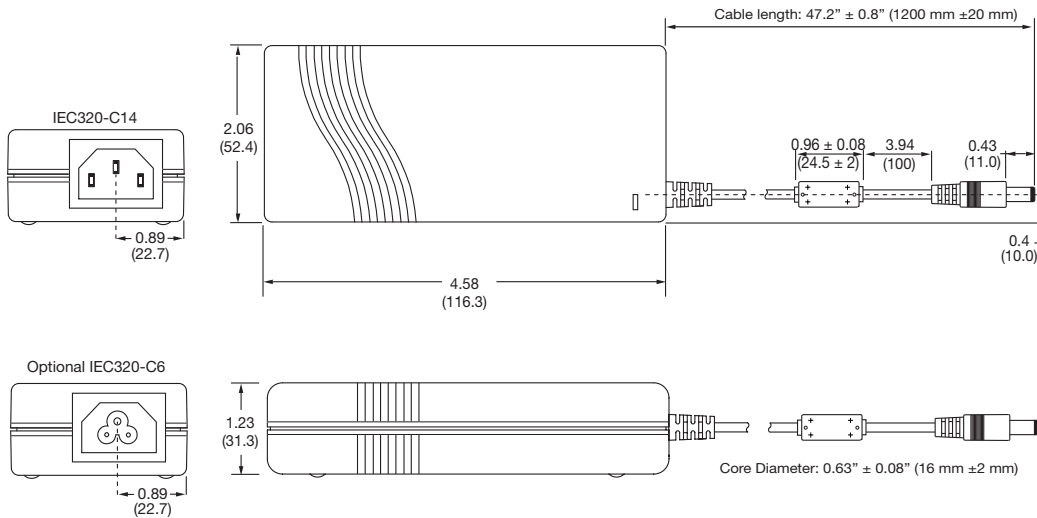

Power Cord for C14 inlet, Order Part:
 UK - UK-MAINS-IEC
 European - EU-MAINS-IEC
 US - US-MAINS-IEC

Power Cord for C6 inlet, Order Part:
 UK - UK-MAINS-5
 European - EU-MAINS-5
 US - US-MAINS-5

Notes

- All dimensions are shown in inches (mm), Tolerance is 0.04" (±1.0) max except output lead.
- Weight: 0.52 lbs (240 g) approx.
- Output connector is barrel type with 11 mm length, 5.5 mm dia. outer, 2.5 mm dia. inner with center + and outer shell - polarity.