

AT 4 Oiltight Limit Switches Complete Units

NEMA 12, 13 / IEC IP 65 / CE

Limit Switches

Contact
N.O. = normally open
N.C. = normally closed
⊕ = safety function with positively opening contacts to IEC/EN 60 947-5-1

Contact Sequence
■ closed
□ open
Zw = positive opening clearance

Plunger
EN 50 041
Form B
Type
Article No.

Price
see price list

Roller plunger
EN 50 041
Form C
Type
Article No.

Price
see price list





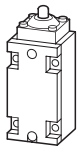

N.O. N.C.

Complete Units



totally insulated

Narrow enclosures



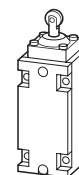

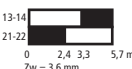



1	1	⊕		 Zw = 4,1 mm	AT4/11-1//S 005244
1	1	⊕		 Zw = 4,9 mm	AT4/11-2//S 097791
1	1	⊕		snap-action contact  Zw = 4,7 mm	AT4/11-S//S 090673

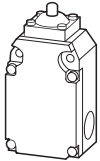





 Zw = 3,6 mm	AT4/11-1//RS 000498
 Zw = 4,4 mm	AT4/11-2//RS 090672
 Zw = 4,3 mm	AT4/11-S//RS 085927

Wide enclosures

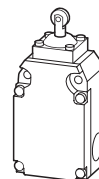





1	1	⊕		 Zw = 4,1 mm	AT4/11-1//A/S 038466
1	1	⊕		 Zw = 4,9 mm	AT4/11-2//A/S 024229
1	1	⊕		snap-action contact  Zw = 4,7 mm	AT4/11-S//A/S 028976

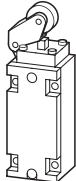
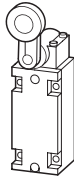
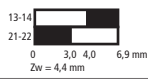
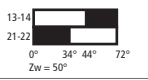
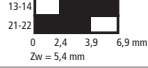

 Zw = 3,6 mm	AT4/11-1//A/RS 031347
 Zw = 4,4 mm	AT4/11-2//A/RS 021856
 Zw = 4,3 mm	AT4/11-S//A/RS 024230

AT 4 Oiltight Limit Switches Complete Units

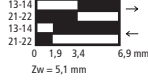
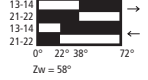
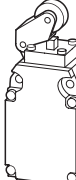
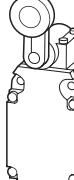
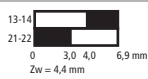
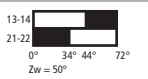
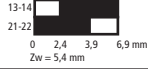
NEMA 12, 13 / IEC IP 65 / CE

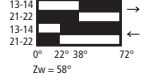
Roller head		Rotary lever EN 50 041 Form A	
Type Article No.	Price see price list	Type Article No.	Price see price list
			
	AT4/11-1/I/AR 085925		AT4/11-1/I/R316 095417
	AT4/11-2/I/AR 076434		AT4/11-2/I/R316 085926
	AT4/11-S/I/AR 062197		AT4/11-S/I/R316 081181
			
	AT4/11-1/IA/AR 017109		AT4/11-1/IA/R316 026601
	AT4/11-2/IA/AR 005245		AT4/11-2/IA/R316 014737
	AT4/11-S/IA/AR 000500		AT4/11-S/IA/R316 019484

Notes

The operating heads can be turned in 90° stages to match the specified direction of operation.

For IP 65 protection, use cable gland M20 with a maximum connection thread length of 9.5mm (V-M20).

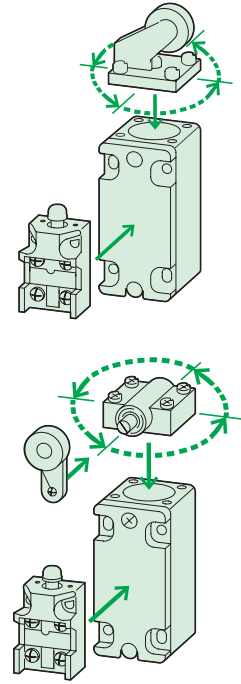

Accessories	Page
Cable glands	06/020

AT 4 Oiltight Limit Switches Complete Units

NEMA 12, 13 / IEC IP 65 / CE

Limit Switches

Contacts
N.O. = normally open
N.C. = normally closed
⊕ = safety function with positively opening contacts to IEC/EN 60 947-5-1

Contact Sequence
■ closed
□ open
Zw = positive opening clearance

N.O. N.C.

Adjustable roller lever

Type
Article No.

Price
see price list

Actuating rod¹⁾

EN 50 041
Form D

Type
Article No.

Price
see price list

Complete Units

totally insulated

Narrow enclosures

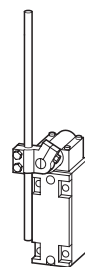
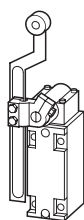

1	1	⊕			AT4/11-1//V 009990		AT4/11-1//H 090671	
1	1	⊕			AT4/11-2//V 000499		AT4/11-2//H 083553	
1	1	⊕			AT4/11-S//V 095419		AT4/11-S//H 076435	

Wide enclosures

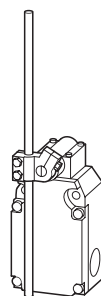
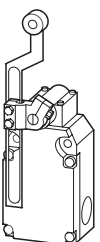





1	1	⊕			AT4/11-1//V 040839		AT4/11-1//H 021855	
1	1	⊕			AT4/11-2//V 031348		AT4/11-2//H 012364	
1	1	⊕			AT4/11-S//V 033722		AT4/11-S//H 014738	

Notes

- 1) Not to be used as a safety limit switch
- 2) Not to be used as a safety limit switch; permissible only with snap-action contact.

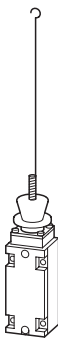
AT 4 Oiltight Limit Switches
Complete Units

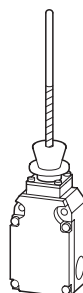
NEMA 12, 13 / IEC IP 65 / CE

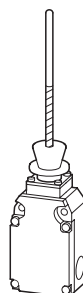
Spring-rod actuator ²⁾					
Type	Price	Type	Price	Type	Price
Article No.	see price list	Article No.	see price list	Article No.	see price list
					
-		-		-	
-		-		-	
	AT4/11-S//F 066943			AT4/11-S//F2 071689	
-		-		-	
-		-		-	
	AT4/11-S//IA/F 005246			AT4/11-S//IA/F2 009992	

Notes

The operating heads can be turned in 90° stages to match the direction of operation.

For IP 65 protection, use cable gland M20 with a maximum connection thread length of 9.5mm (V-M20).

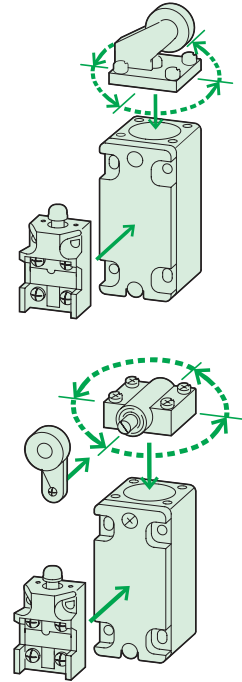

Accessories

Cable glands

Page

06/020

AT 4 Oiltight Limit Switches Components

Contacts
 N.O. = normally open
 N.C. = normally closed
 ⊕ = safety function with positively opening clearance to IEC/EN 60 947-5-1
 N.O. N.C.

Contact Sequence

 closed
 open
 Zw = positive opening clearance

Type
 Article No. **Price**
 see price list

Switch mechanisms

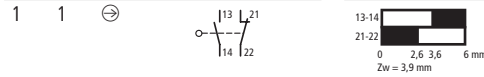
for mounting into the following insulated enclosures



ATB11-1
069314

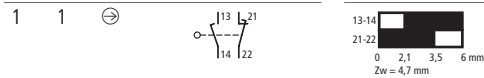

ATB11-2
071687

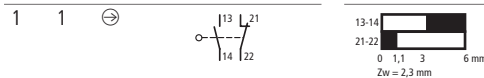

ATB11-3
077210

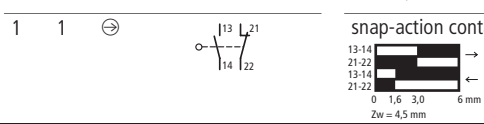

ATB11-5
074060

Insulated enclosure NEMA 12, 13 / IP 65

for housing the above switch mechanisms

Narrow version to EN 50 041

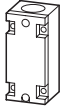

I-AT4
055226

Wide version



IA-AT4
074212

Operating heads

for mounting on the above insulated enclosures

Plunger head to EN 50 041



S-AT4
095692

Roller plunger head to EN 50 041



RS-AT4
024502

Actuating roller head



AR-AT4
088344

Spring-rod actuator head, rod length 160 mm¹⁾

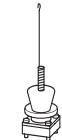

F-AT4
090792

Spring-rod actuator head, rod length 130 mm¹⁾

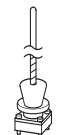





F2-AT4
036214

Notes

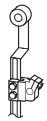
¹⁾ Not to be used as safety limit switch; permissible only with snap-action contact.

AT 4 Oiltight Limit Switches Components

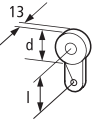
	Max. operating speed lateral m/s	Angle of operation Degrees	Lever length <i>l</i> mm	Diameter <i>d</i> mm	Type Article No.	Price see price list	
Operating heads							
for combination with the insulated enclosures opposite							
Rotary drive head	3	15			R-AT4 095687		
• for combination with the actuators below	1.5	50					
Actuators							
Adjustable roller lever	2.3 1.1	15 50	150	–	HV 019631		
							
Actuating rod ¹⁾ • with adjustable aluminum rod	1.4	–	190	–	HH-A 063268		
							
Actuating rod ¹⁾ • with plastic rod	1.4	–	190	–	HH-K 063267		
							
Actuating roller lever ²⁾ • with plastic roller			30	18	HR311 059970		
				30	22		HR313 064716
				30	30		HR316 069462
				30	40		HR317 071835
				30	50		HR318 074208
				37.5	18		HR411 088446
				37.5	22		HR413 093192
				37.5	30		HR416 097938
				37.5	40		HR417 012511
				37.5	50		HR418 014884
			50	18	HR511 033868		
			50	22	HR513 038614		
			50	30	HR516 043360		
			50	40	HR517 045733		
			50	50	HR518 048106		

Notes
¹⁾ Not to be used as a safety limit switch; permissible only with snap-action contact.
²⁾ For non-standard rollers, please inquire.

Notes

The operating heads can be turned in 90° stages to match the specified direction of operation.

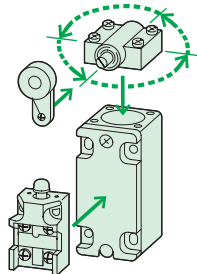

With the rotary drive, the method of closing contacts can be selected to suit the direction of operation simply by turning the plunger components.

Contact closed in both directions

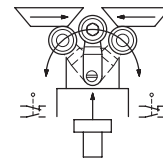

only when actuated from the right

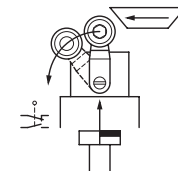

only when actuated from the left

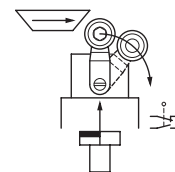

For IP 65 protection, use cable gland M20 with a maximum connection thread length of 9.5mm (V-M20).

Accessories	Page
Cable glands	06/020