

**D-Sub – High Density subminiature D connectors**

Page

Technical characteristics ..... **03.02**

Connectors  
with crimp terminal / crimp contacts ..... **03.03**



Connectors  
with straight solder cups ..... **03.06**

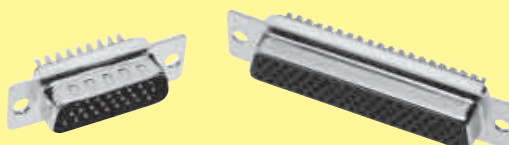

Connectors  
with angled solder pins ..... **03.08**



Connectors  
with straight solder pins ..... **03.11**



D-Sub - HD

Number of contacts	15, 26, 44, 62, 78 UL recognized
Working current Stamped contacts	2 A max.
Test voltage $U_{r.m.s.}$	1 kV
Clearance and creepage	$\geq 1.0$ mm
Contact resistance	$\leq 20$ m $\Omega$
Insulation resistance	$\geq 5 \times 10^9$ $\Omega$
Temperature range	-55 °C ... + 105 °C The higher temperature limit includes the local ambient and heating effect of the contacts under load
Terminations	<ul style="list-style-type: none"> <li>a) Solder pins <math>\varnothing</math> 0.65 mm for P.C.B. holes <math>\varnothing</math> 1.02 mm</li> <li>b) Solder pins, angled 90° <math>\varnothing</math> 0.7 mm for P.C.B. holes <math>\varnothing</math> 1.02 mm</li> <li>c) Crimp contacts 0.14 - 0.22 mm<sup>2</sup> AWG 26 - 24 max. insulation <math>\varnothing</math> 1.38 mm</li> <li>d) Solder cups AWG 22</li> </ul>
Materials	
Mouldings and hoods	Thermoplastic resin, glass-fibre filled (PBTP), UL 94-V0
Contacts	Copper alloy
Contact surface	
Contact zone	selectively gold-plated according to performance level <sup>1)</sup>
Metal shell	Plated steel
Mating force	
	15 way $\leq 46$ N
	26 way $\leq 77$ N
	44 way $\leq 127$ N
	62 way $\leq 177$ N
	78 way $\leq 222$ N

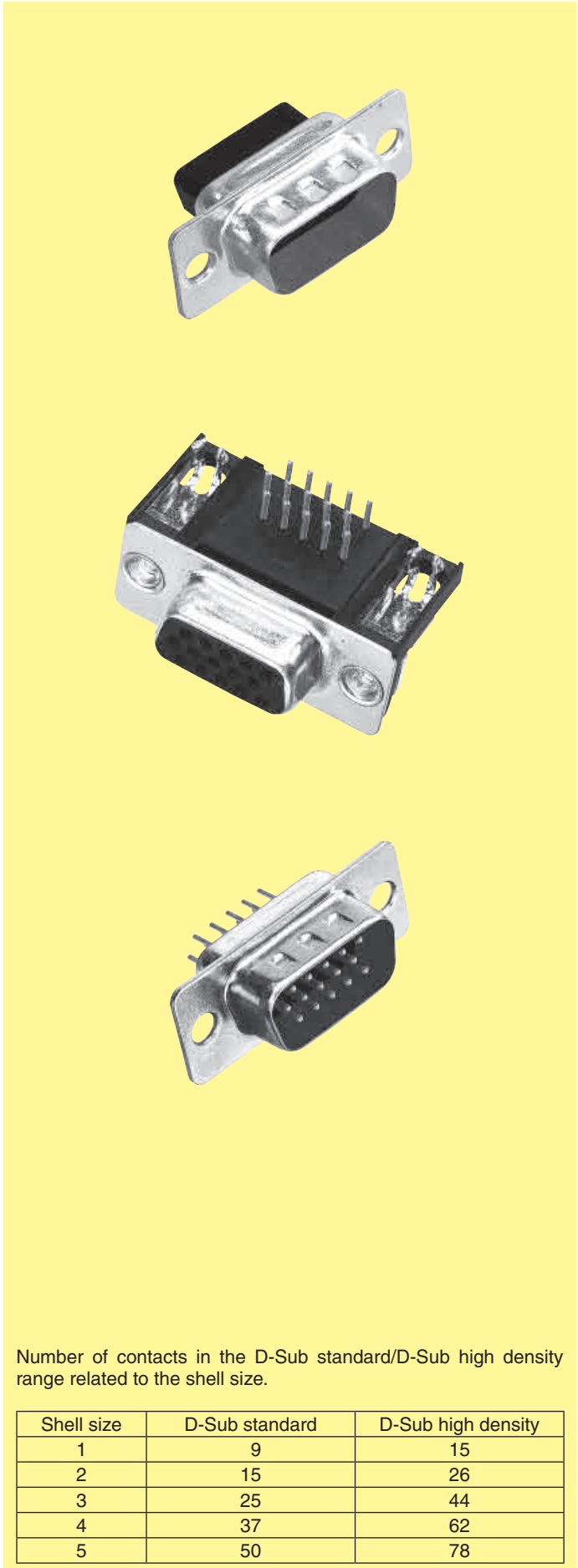

Number of contacts in the D-Sub standard/D-Sub high density range related to the shell size.

Shell size	D-Sub standard	D-Sub high density
1	9	15
2	15	26
3	25	44
4	37	62
5	50	78

<sup>1)</sup> Performance level 3, 50 mating cycles, no gas test S4, plating  $\geq 0.76$   $\mu$ m Au (30  $\mu$ inch)

Number of contacts

# 15-78



High density crimp terminal

Identification	No. of contacts	Part No.
Male connector Order contacts separately  metal shell with dimples	15	09 56 100 5601
	26	09 56 200 5601
	44	09 56 300 5601
	62	09 56 400 5601
	78	09 56 500 5601
Female connector Order contacts separately  metal shell	15	09 56 100 4701
	26	09 56 200 4701
	44	09 56 300 4701
	62	09 56 400 4701
	78	09 56 500 4701

D-Sub - HD

Male connector

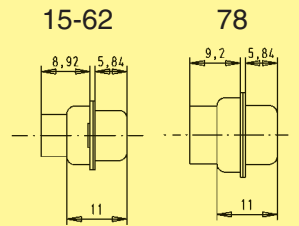
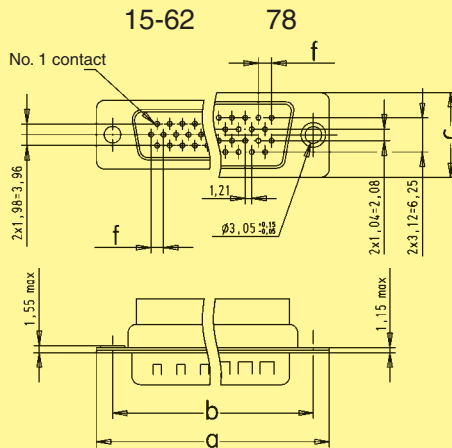

	a	b $\pm 0.13$	c	f
15	30.9	25.0	12.5	2.29
26	39.2	33.3	12.5	2.29
44	53.1	47.0	12.5	2.29
62	69.4	63.5	12.5	2.41
78	67.0	61.1	15.4	2.41

Female connector

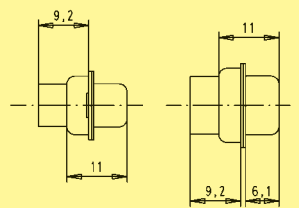
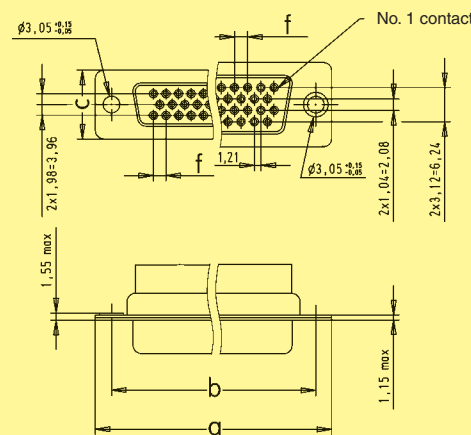

Panel cut out for front/rear mount

Values are taken from the CECC 75301-802

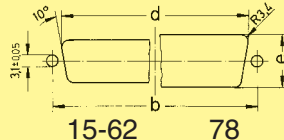

Front mount

	b $\pm 0.13$	d $\pm 0.2$	e $\pm 0.2$
15	25.0	22.2	12.3
26	33.3	30.5	12.3
44	47.0	44.3	12.3
62	63.5	60.7	12.3
78	61.1	58.3	15.1

Rear mount

	b $\pm 0.13$	d $\pm 0.2$	e $\pm 0.2$
15	25.0	20.5	11.4
26	33.3	28.8	11.4
44	47.0	42.5	11.4
62	63.5	59.1	11.4
78	61.1	56.3	14.1

Dimensions in mm

03  
03

Crimp contacts for high density connectors



D-Sub - HD

Identification	Wire gauge (mm <sup>2</sup> )	Part No.			
		stamped male contacts		stamped female contacts	
Performance levels Explanations see page 03.02 Other performance levels on request		Performance level 3	S4 <sup>1)</sup>	Performance level 3	S4 <sup>1)</sup>
500 pieces/box	0.14-0.22 AWG 26-24 stranded	09 56 000 8177	09 56 000 8175	09 56 000 8277	09 56 000 8275
500 pieces/reel Unrolling left		09 56 000 8167	09 56 000 8165	09 56 000 8267	09 56 000 8265
10 000 pieces/reel Unrolling left		09 56 000 8157	09 56 000 8155	09 56 000 8257	09 56 000 8255
Unrolling direction		<p>500 pieces/reel Unrolling left      10 000 pieces/reel Unrolling left</p> <p>for HARTING tools</p>			

<sup>1)</sup> S4: ≥ 0.76 μm Au (30 μinch)  
Contact dimensions see page 03.05

Crimp contacts for high density connectors



Identification

Drawing

Dimensions in mm

## Male contacts

wire gauge AWG 26-24

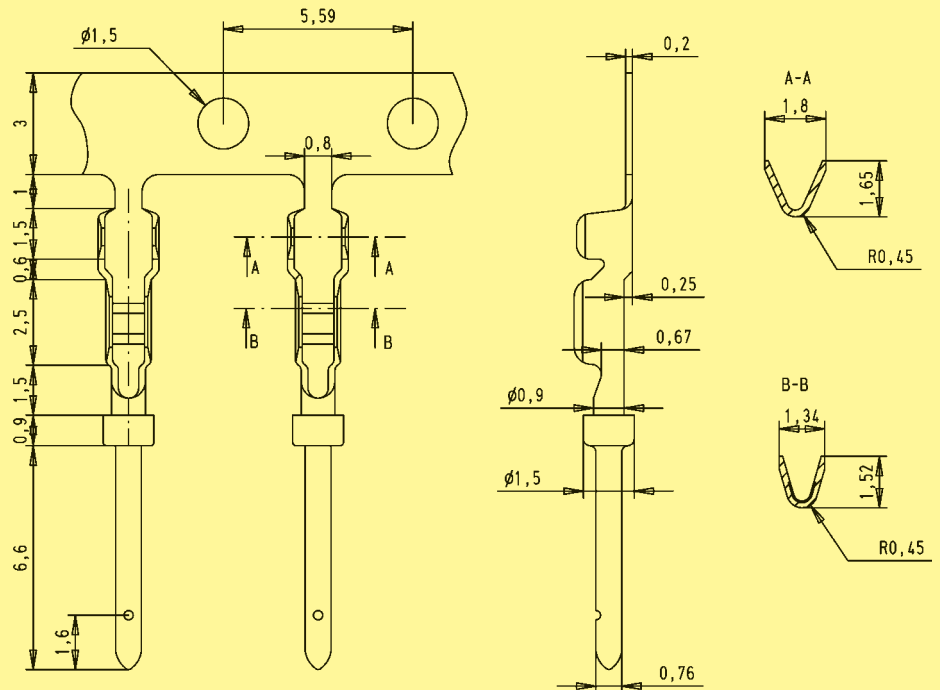

## Female contacts

wire gauge AWG 26-24

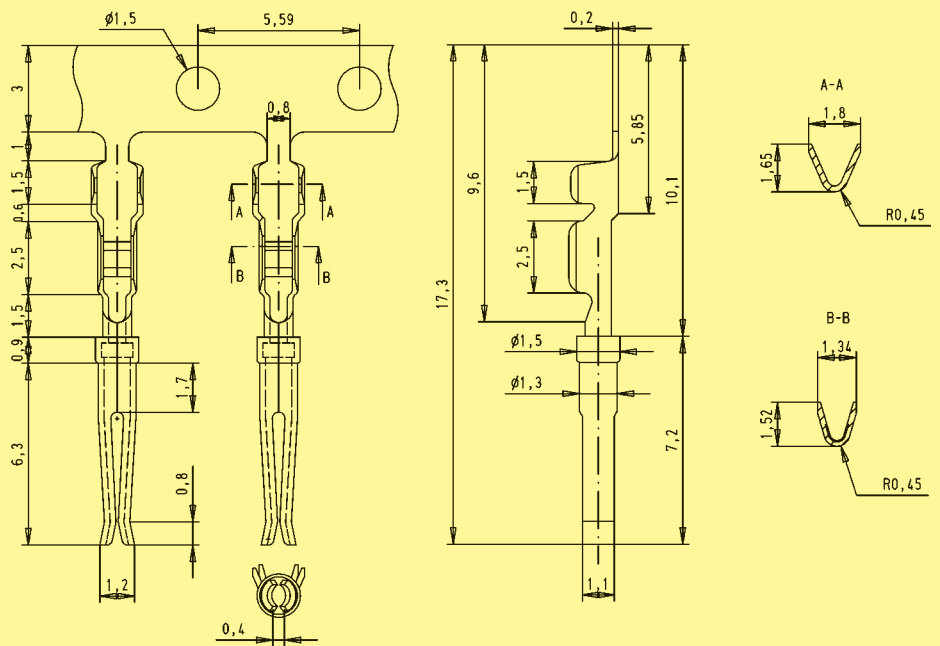

Number of contacts

15-78



High density with stamped solder cups, straight

D-Sub - HD

Identification	No. of contacts	Part No.	
<b>Performance levels</b> Explanations see page 03.02 Other performance levels on request		Performance level <b>3</b>	<b>S4<sup>1)</sup></b>
<b>Male connector</b> metal shell with dimples			
<b>Female connector</b> metal shell			
	15 26 44 62 78	09 56 100 5604 09 56 200 5604 09 56 300 5604 09 56 400 5604 09 56 500 5604	09 56 100 5615 050 09 56 200 5615 050 09 56 300 5615 050 09 56 400 5615 050 09 56 500 5615 050
	15 26 44 62 78	09 56 100 4704 09 56 200 4704 09 56 300 4704 09 56 400 4704 09 56 500 4704	09 56 100 4715 050 09 56 200 4715 050 09 56 300 4715 050 09 56 400 4715 050 09 56 500 4715 050

<sup>1)</sup> S4: ≥ 0.76 µm Au (30 µinch)

Number of contacts

# 15-78



High density with stamped solder cups, straight

Identification

Drawing

Dimensions in mm

Male connector

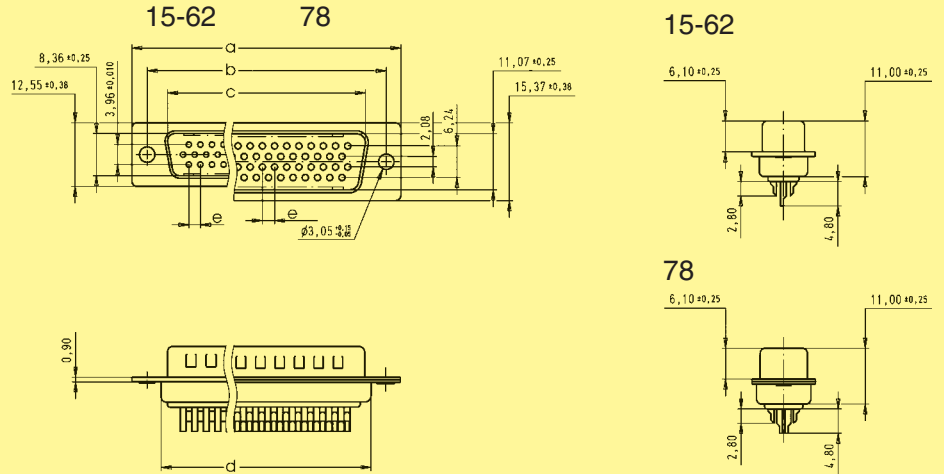

	a	b	c	d	e	f
15	30.89	24.99	16.92	19.28	2.29	16.33
26	39.10	33.32	25.25	27.51	2.29	24.66
44	53.09	47.04	38.96	41.30	2.29	38.38
62	69.40	63.50	55.25	57.71	2.42	54.84
78	66.93	61.11	52.81	55.32	2.42	52.43

Female connector

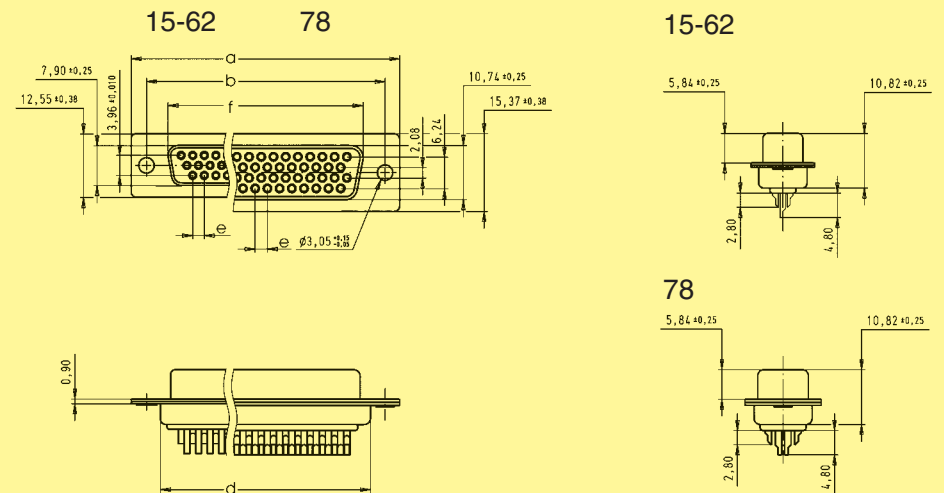

Number of contacts

# 15-78

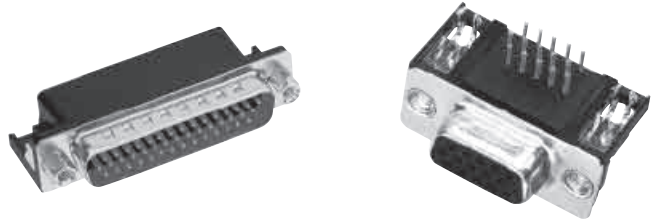

High density with stamped solder pins, angled with grounding board locks

D-Sub - HD

Identification	No. of contacts	Part No.	
<b>Performance levels</b> Explanations see page 03.02 Other performance levels on request		Performance level <b>3</b>	
		<b>S4<sup>1)</sup></b>	
<b>Male connector</b> metal shell with dimples			
	15	09 56 162 781 .	09 56 162 581 .
	26	09 56 262 781 .	09 56 262 581 .
	44	09 56 362 781 .	09 56 362 581 .
	62	09 56 462 781 .	09 56 462 581 .
<b>Female connector</b> metal shell			
	15	09 56 152 761 .	09 56 152 561 .
	26	09 56 252 761 .	09 56 252 561 .
	44	09 56 352 761 .	09 56 352 561 .
	62	09 56 452 761 .	09 56 452 561 .
	78	09 56 552 761 .	09 56 552 561 .
Please insert digit for flange thread or fitted female screw locks			
4-40 UNC ▶	<b>2</b>		
fitted screw locks 4-40 UNC ▶	<b>3</b>		

<sup>1)</sup> S4: ≥ 0.76 μm Au (30 μinch)



Number of contacts

# 15-78

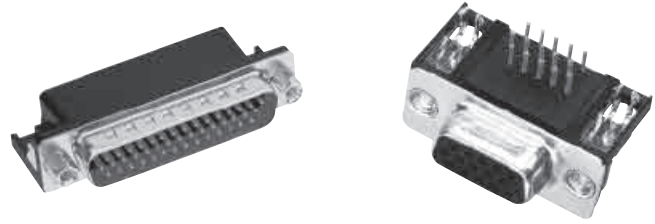

High density with stamped solder pins, angled with grounding board locks

Identification

Drawing

Dimensions in mm

Male connector

No. 1 contact

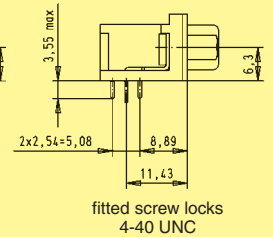
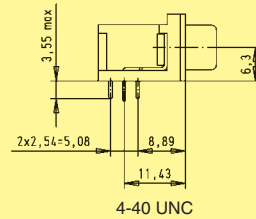
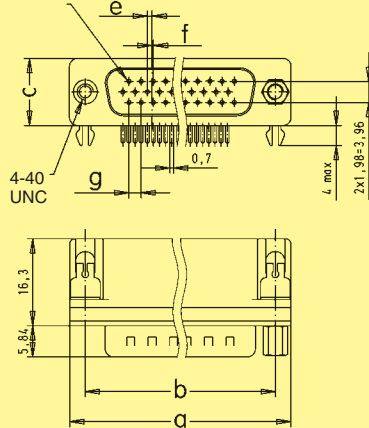

	a	b $\pm 0.1$	c	e	f	g
15	30.9	25.0	12.5	0.89	0.25	2.29
26	39.2	33.3	12.5	0.64	0.51	2.29
44	53.1	47.0	12.5	0.64	0.51	2.29
62	69.4	63.5	12.5	0.62	0.58	2.41
78	67.0	61.1	15.4	-	-	2.41

Female connector

15-62 78

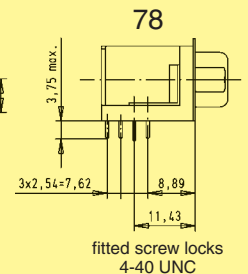
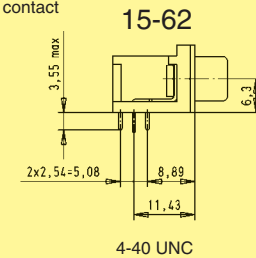
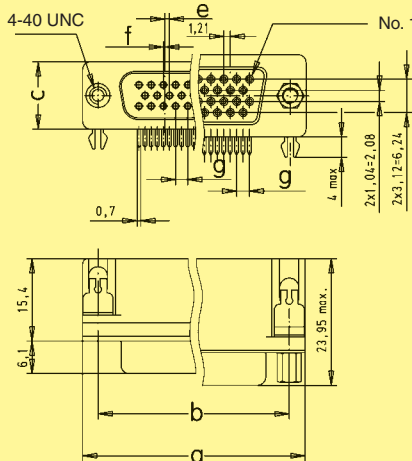

Board drillings

male

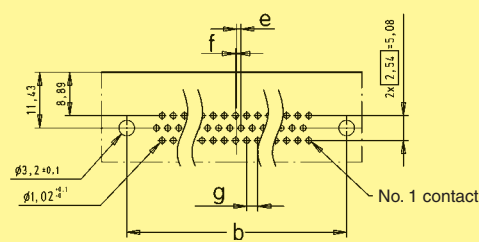

female 15-62

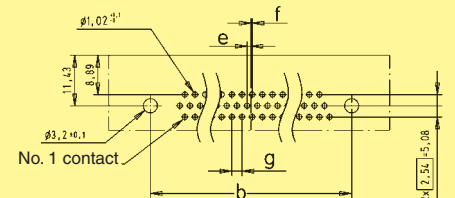

female 78

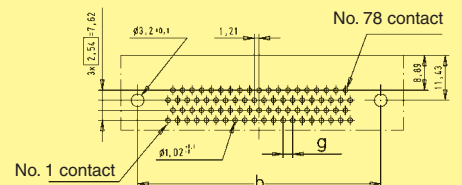



Number of contacts

# 15-78



High density with stamped solder pins, straight

Identification	No. of contacts	Part No.	
<b>Performance levels</b> Explanations see page 03.02 Other performance levels on request		Performance level <b>3</b>	<b>S4<sup>1)</sup></b>
<b>Male connector</b> metal shell with dimples	15 26 44 62 78	09 56 161 7700 09 56 261 7700 09 56 361 7700 09 56 461 7700 09 56 561 7700	09 56 161 5700 09 56 261 5700 09 56 361 5700 09 56 461 5700 09 56 561 5700
<b>Female connector</b> metal shell	15 26 44 62 78	09 56 151 7500 09 56 251 7500 09 56 351 7500 09 56 451 7500 09 56 551 7500	09 56 151 5500 09 56 251 5500 09 56 351 5500 09 56 451 5500 09 56 551 5500

D-Sub - HD

Male connector

15-62    78                      15-62    78

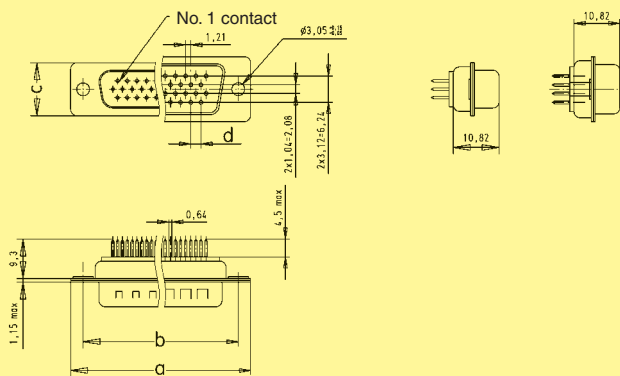

Female connector

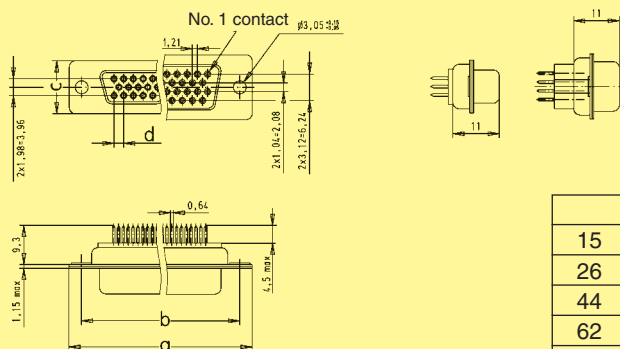

	a	b <sub>±0.1</sub>	c	d
15	30.9	25.0	12.5	2.29
26	39.2	33.3	12.5	2.29
44	53.1	47.0	12.5	2.29
62	69.4	63.5	12.5	2.41
78	67.0	61.1	15.4	2.41

Board drillings

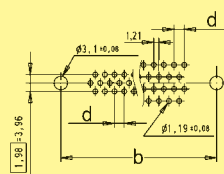

Dimensions in mm

<sup>1)</sup> S4: ≥ 0.76 μm Au (30 μinch)

Number of contacts

# 15-78

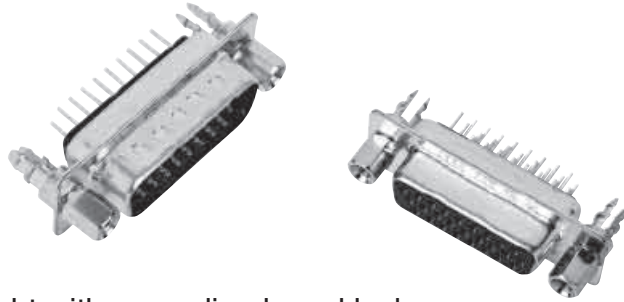

High density with stamped solder pins, straight with grounding board locks

D-Sub - HD

Identification	No. of contacts	Part No.	
<b>Performance levels</b> Explanations see page 03.02 Other performance levels on request		Performance level <b>3</b>	
		<b>S4<sup>1)</sup></b>	
<b>Male connector</b> metal shell with dimples			
	15	09 56 161 771 .	09 56 161 571 .
	26	09 56 261 771 .	09 56 261 571 .
	44	09 56 361 771 .	09 56 361 571 .
	62	09 56 461 771 .	09 56 461 571 .
	78	09 56 561 771 .	09 56 561 571 .
<b>Female connector</b> metal shell			
	15	09 56 151 751 .	09 56 151 551 .
	26	09 56 251 751 .	09 56 251 551 .
	44	09 56 351 751 .	09 56 351 551 .
	62	09 56 451 751 .	09 56 451 551 .
	78	09 56 551 751 .	09 56 551 551 .
Please insert digit for flange thread or fitted female screw locks			
4-40 UNC ▶ 2			
fitted screw locks 4-40 UNC ▶ 3			

<sup>1)</sup> S4: ≥ 0.76 μm Au (30 μinch)

Number of contacts

# 15-78

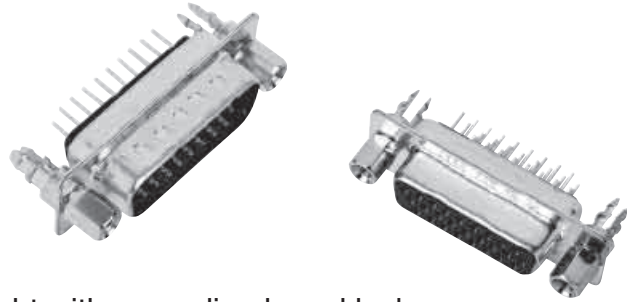

High density with stamped solder pins, straight with grounding board locks

Identification

Drawing

Dimensions in mm

Male connector

15-62      78

15-62      78

4-40 UNC      fitted screw locks  
4-40 UNC

	a	b $\pm 0.1$	c	e	f	g
15	30.9	25.0	12.5	0.89	0.25	2.29
26	39.2	33.3	12.5	0.64	0.51	2.29
44	53.1	47.0	12.5	0.64	0.51	2.29
62	69.4	63.5	12.5	0.62	0.58	2.41
78	67.0	61.1	15.4	—	—	2.41

Female connector

15-62      78

15-62      78

4-40 UNC      fitted screw locks  
4-40 UNC

Board drillings

male 15-62

female 15-62

male 78

female 78

