

2.4/5GHZ BALANCE ANTENNA(34.9MM*9MM)

1.0 SCOPE

This specification describes the antenna application and surrounding. The information in this document is for reference and benchmark purposes only. The user is responsible for validating antenna RF performance based on the user's actual implementation.

All measurements are done of the antenna mounted on a PC/ABS material block of 1mm thickness with VNA Agilent 5071C and OTA chamber. All measurements are done with the part no. 1461530100 with a cable length of 100mm.

Antenna illustrations in this document are generic representations. They are not intended to be an image of any antenna listed in the scope.

2.0 PRODUCT DESCRIPTION

A. DEFINITIONS OF TERMS

The overall antenna size is 34.9mm*9mm (figure 1).

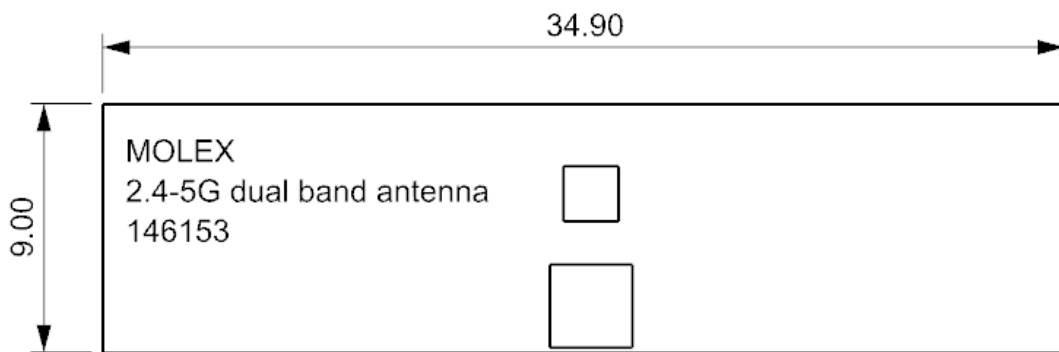

Figure 1 Dimension of the 2.4/5GHz Balance Antenna

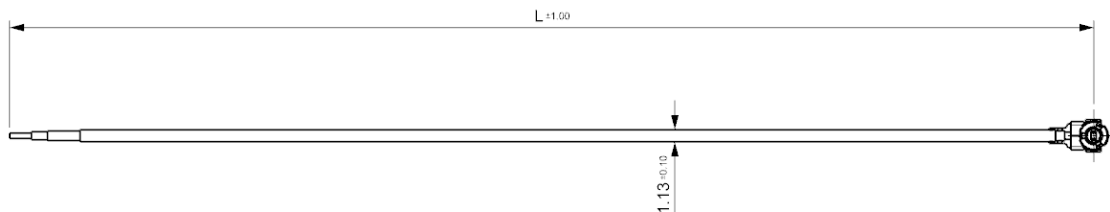

Figure 2 Cable line view of 2.4/5GHz Balance Antenna

B. RF PERFORMANCE OF ANTENNA LOADED WITH PC/ABS MATERIAL BLOCK OF 1MM THICKNESS IN FREE SPACE

REVISION: B	ECR/ECN INFORMATION: EC No: ABU2016-0022 DATE: 2015/04/14	TITLE: 2.4/5GHz Balance Antenna (34.9mm*9mm) Application Specification	SHEET No. 1 of 10
DOCUMENT NUMBER: AS-146153-100	CREATED / REVISED BY: Stephen Hu 2015/08/28	CHECKED BY: Chris Zhong 2015/08/28	APPROVED BY: Welson Tan 2015/08/28

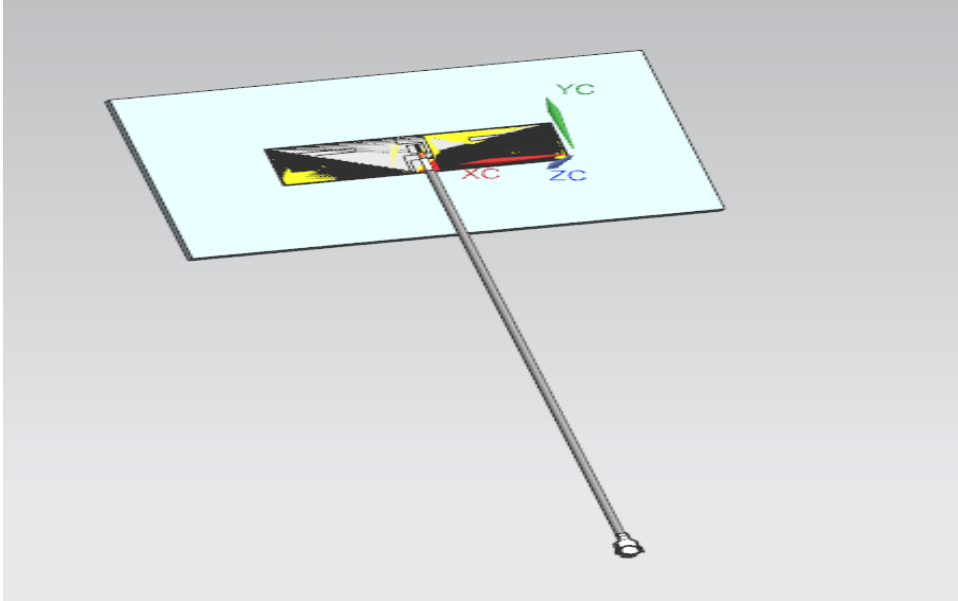

FIGURE3 ANTENNA LOADED WITH PC/ABS BLOCK OF 1MM THICKNESS

DESCRIPTION	TEST CONDITION	REQUIREMENT	
Frequency Range	2.4GHz~5.85GHz	2.4GHz~2.5GHz	5.15GHz~5.85GHz
Return Loss	Antenna loads on PC/ABS housing (thickness 1mm)with 100mm; 1.13mm diameter micro coax cable. Measured by VNA5071C	< -10 dB	
Peak Gain	Measure antenna on recommended PC/ABS housing through OTA chamber	3.0 dBi	4.5 dBi
Total Efficiency	Measure antenna on recommended PC/ABS housing through OTA chamber	>75%	>70%
Polarization	Measure antenna through the OTA chamber	Linear	
Input Impedance	Measure antenna on recommended PCB through VNA E5071C	50Ohms	

REVISION: B	ECR/ECN INFORMATION: EC No: ABU2016-0022 DATE: 2015/04/14	TITLE: 2.4/5GHz Balance Antenna (34.9mm*9mm) Application Specification	SHEET No. 2 of 10
DOCUMENT NUMBER: AS-146153-100	CREATED / REVISED BY: Stephen Hu 2015/08/28	CHECKED BY: Chris Zhong2015/08/28	APPROVED BY: Welson Tan 2015/08/28

3.0 REFERENCE DOCUMENTS

- ENGINEERING DRAWING – E-146153-100
- PRODUCT SPECIFICATION – PS-146153-100
- PACKAGING INFORMATION – REFER TO THE MOLEX RELATED PACKAGING DRAWINGS.

4.0 RF PERFORMANCE AS A FUNCTION OF IMPLEMENTATION

4.0.1 ANTENNA RF PERFORMANCE AS A FUNCTION OF DIFFERENT LOCATION WITH HORIZONTAL GROUND

4 ground locations have been evaluated, and these locations are show in figure 5. The antennas meet the spec of the return loss and the total efficiency specification at location 4. The minimum ground distance from antenna is recommended to be 20mm from the antenna to meet the antenna specification.

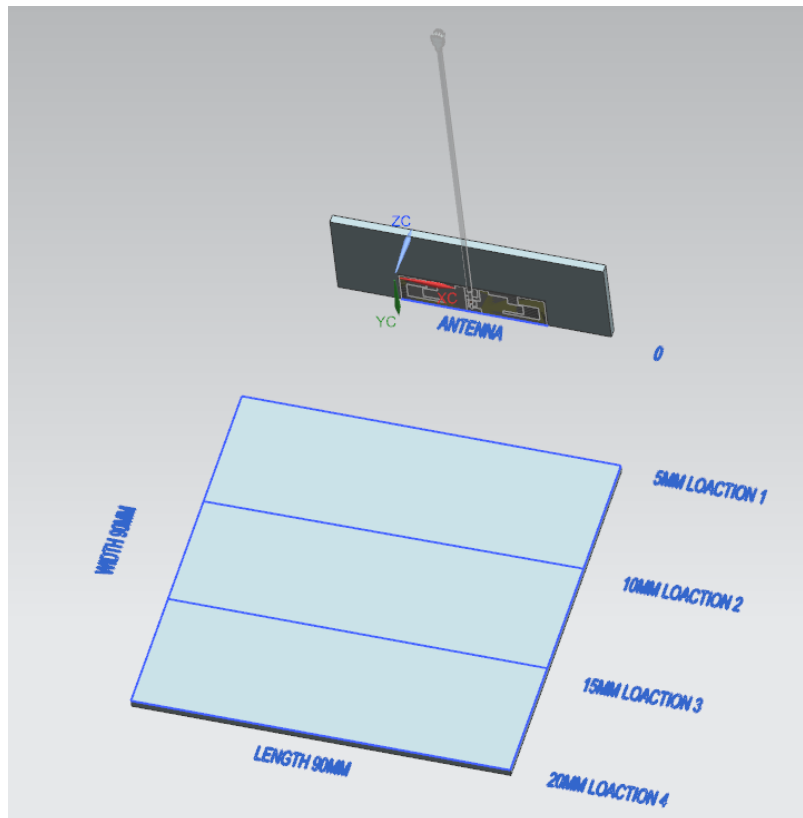

Figure 5

REVISION: B	ECR/ECN INFORMATION: EC No: ABU2016-0022 DATE: 2015/04/14	TITLE: 2.4/5GHz Balance Antenna (34.9mm*9mm) Application Specification	SHEET No. 3 of 10
DOCUMENT NUMBER: AS-146153-100	CREATED / REVISED BY: Stephen Hu 2015/08/28	CHECKED BY: Chris Zhong 2015/08/28	APPROVED BY: Welson Tan 2015/08/28



APPLICATION SPECIFICATION

Ground Area: 90mm*90mm

- (a) Location 1: Distance between antenna and ground is about 5mm.
- (b) Location 2: Distance between antenna and ground is about 10mm
- (c) Location 3: Distance between antenna and ground is about 15mm.
- (d) Location 4: Distance between antenna and ground is about 20mm.

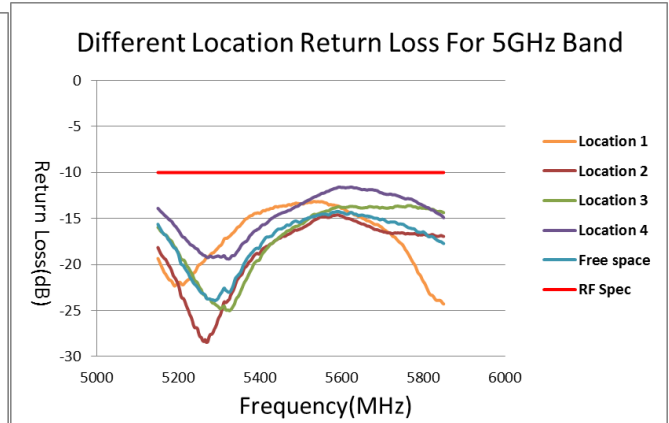
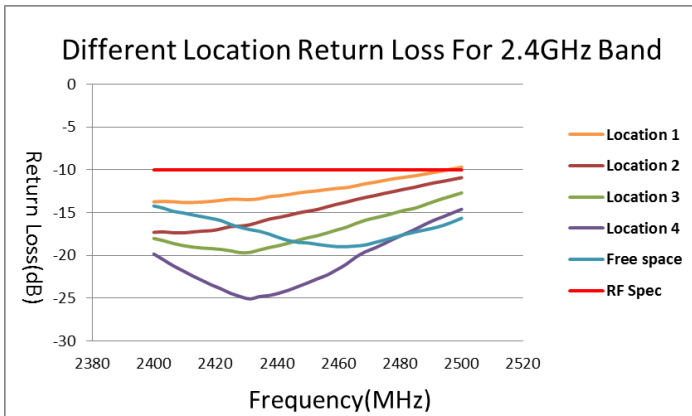

RETURN LOSS PLOT

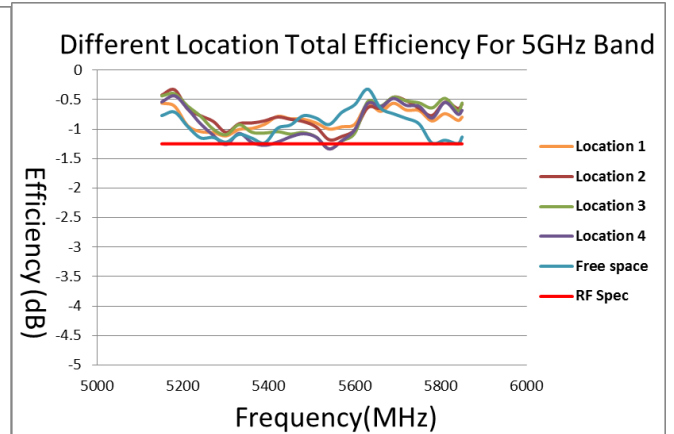
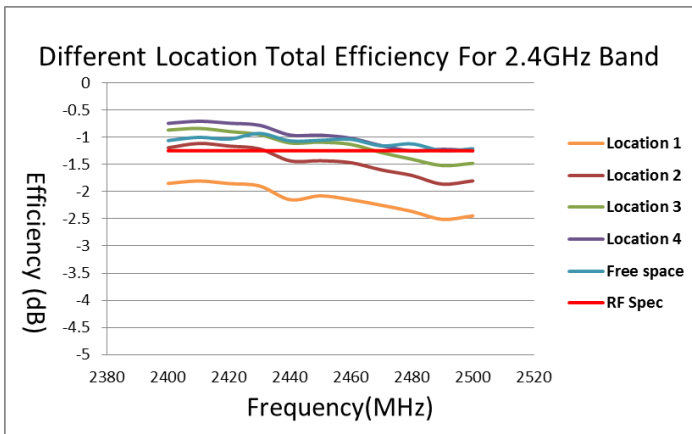

TOTAL EFFICIENCY PLOT

REVISION: B	ECR/ECN INFORMATION: EC No: ABU2016-0022 DATE: 2015/04/14	TITLE: 2.4/5GHz Balance Antenna (34.9mm*9mm) Application Specification	SHEET No. 4 of 10
DOCUMENT NUMBER: AS-146153-100	CREATED / REVISED BY: Stephen Hu 2015/08/28	CHECKED BY: Chris Zhong 2015/08/28	APPROVED BY: Welson Tan 2015/08/28

4.0.2 ANTENNA RF PERFORMANCE AS A FUNCTION OF DIFFERENT LOCATION WITH VERTICAL GROUND

4 ground locations have been evaluated, with different distances from the antenna, and these locations are show in figure 6. The antenna did not meet the return loss at 2.4GHZ band at location4 although can meet the efficiency specification. The minimum ground distance from the ground is recommended to be 20mm distance from the antenna to meet the total efficiency specification.

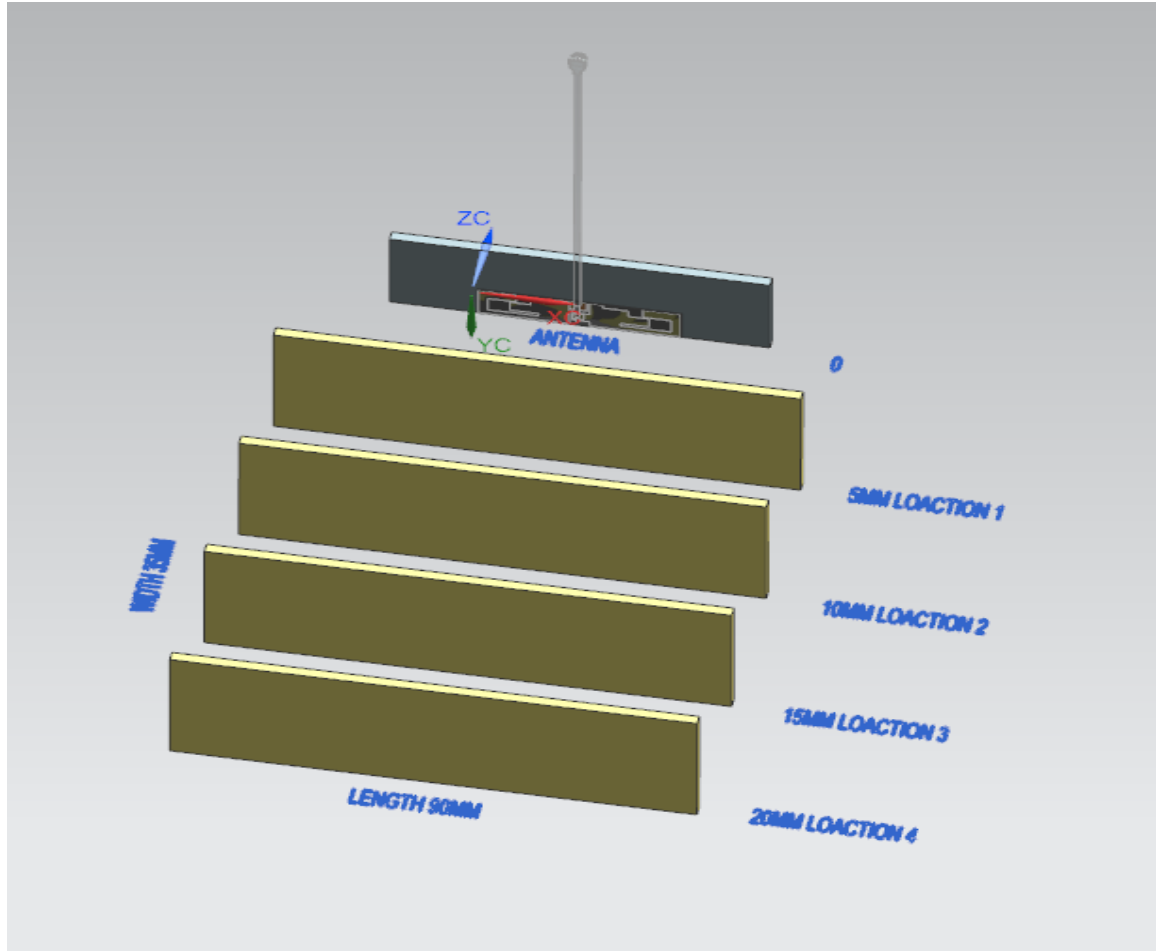

Figure 6

Ground Area: 90mm*90mm

- (e) Location 1: Distance between antenna and ground is about 5mm
- (f) Location 2: Distance between antenna and ground is about 10mm.
- (g) Location 3: Distance between antenna and ground is about 15mm.
- (h) Location 4: Distance between antenna and ground is about 20mm.

REVISION: B	ECR/ECN INFORMATION: EC No: ABU2016-0022 DATE: 2015/04/14	TITLE: 2.4/5GHz Balance Antenna (34.9mm*9mm) Application Specification	SHEET No. 5 of 10
DOCUMENT NUMBER: AS-146153-100	CREATED / REVISED BY: Stephen Hu 2015/08/28	CHECKED BY: Chris Zhong2015/08/28	APPROVED BY: Welson Tan 2015/08/28



APPLICATION SPECIFICATION

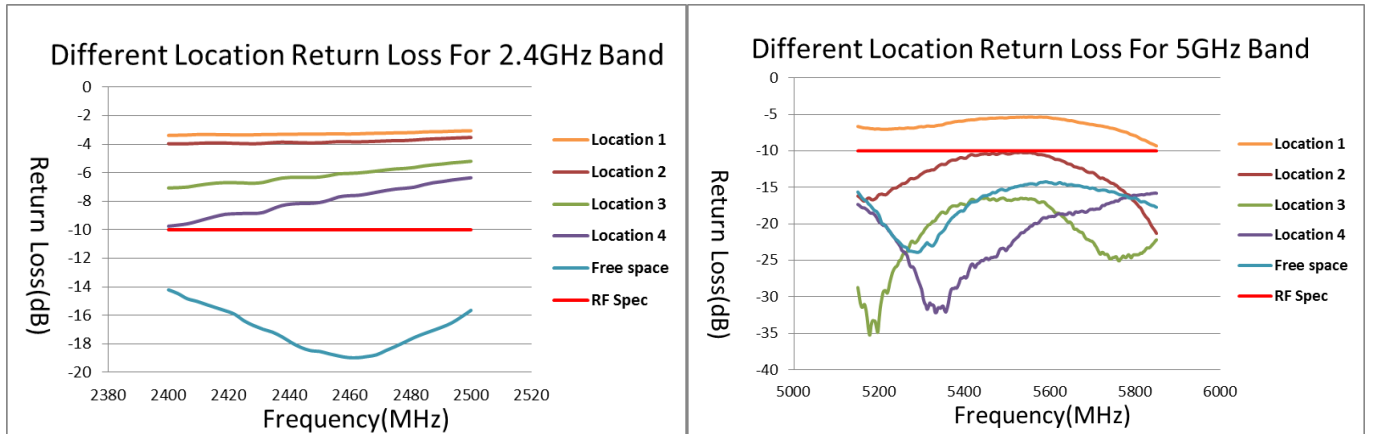

RETURN LOSS PLOT

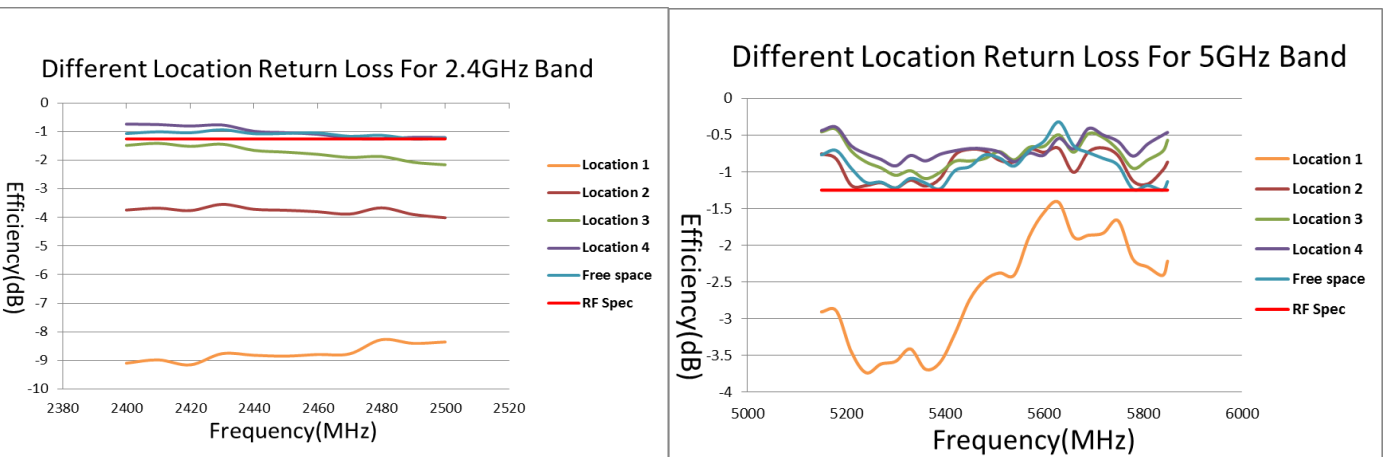

TOTAL EFFICIENCY PLOT

REVISION: B	ECR/ECN INFORMATION: EC No: ABU2016-0022 DATE: 2015/04/14	TITLE: 2.4/5GHz Balance Antenna (34.9mm*9mm) Application Specification	SHEET No. 6 of 10
DOCUMENT NUMBER: AS-146153-100	CREATED / REVISED BY: Stephen Hu 2015/08/28	CHECKED BY: Chris Zhong 2015/08/28	APPROVED BY: Welson Tan 2015/08/28

5.0 RADIATION PATTERN

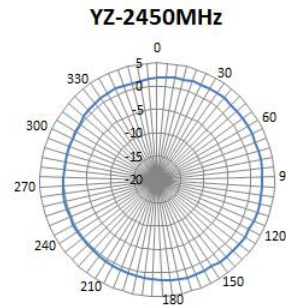
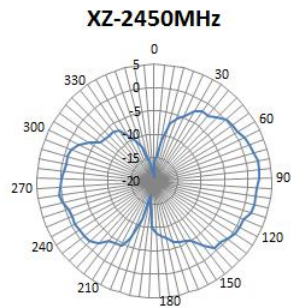
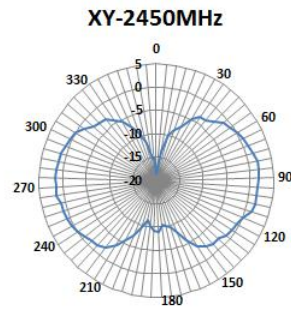
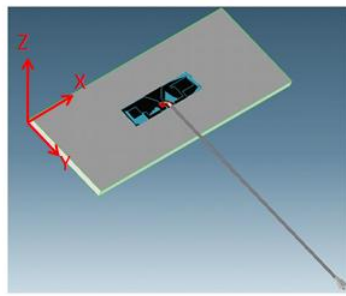

Figure 5.1 Radiation Pattern of antenna at 2.45GHz at Location 1

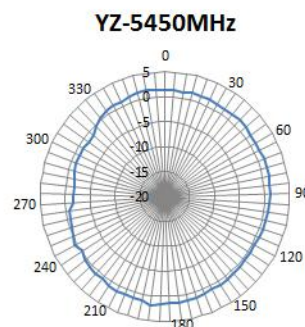
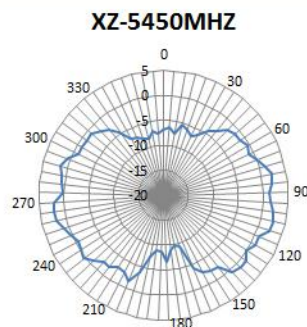
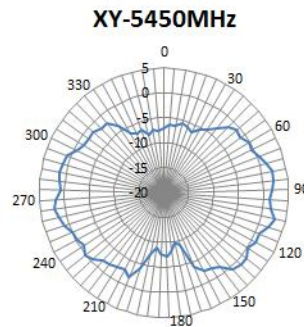
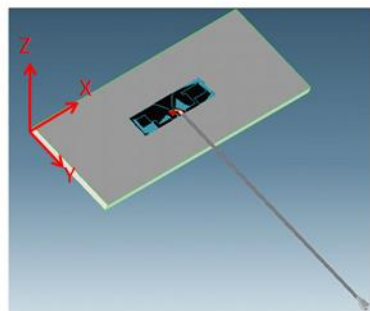

Figure 5.2 Radiation Pattern of antenna at 5.45GHz at Location 1

REVISION:	ECR/ECN INFORMATION:	TITLE:		SHEET No.
B	EC No: ABU2016-0022 DATE: 2015/04/14	2.4/5GHz Balance Antenna (34.9mm*9mm) Application Specification		7 of 10
DOCUMENT NUMBER:	CREATED / REVISED BY:	CHECKED BY:	APPROVED BY:	
AS-146153-100	Stephen Hu 2015/08/28	Chris Zhong2015/08/28	Welson Tan 2015/08/28	
<small>TEMPLATE FILENAME: APPLICATION_SPEC[SIZE_A](V.1).DOC</small>				



APPLICATION SPECIFICATION

6.0 THE ANTENNA PERFORMANCE RELATION WITH CABLE LENGTH

6.0.1 CABLE LOSS

ITEM	DESCRIPTION	TEST CONDITION	REQUIREMENT	
6.0.1.1	Frequency Range	2 GHz~6GHz	2GHz~3GHz	5GHz~6.0GHz
6.0.1.2	Attenuation	1m cable. Measured by VNA5071C	≤3.5dB/m	≤5dB/m

6.0.2 CABLE LENGTH AFFECT THE ANTENNA PERFORMANCE

Balance antenna resonance is insensitive by cable's length, but the cable's loss will affect the total efficiency. Refer to 6.0.1

6.0.3 FOR EXAMPLE

Base on the 100mm cable performance, we can mostly compute the 300mm cable's.

Frequency (MHz)	100mm cable		cable loss	300mm cable	
	Efficiency (dB)	Efficiency (%)		Efficiency (dB)	Efficiency (%)
	X		X-LOSS=Y	Y	
2400	-1.06132	78.3192	0.2m*3.5dB/m	-1.76132	66.66
2410	-1.00181	79.3997		-1.70181	67.58
2420	-1.03427	78.8086		-1.73427	67.08
2430	-0.929705	80.729		-1.629705	68.71
2440	-1.06668	78.2226		-1.76668	66.58
2450	-1.05499	78.4334		-1.75499	66.76
2460	-1.03892	78.7241		-1.73892	67.01
2470	-1.15769	76.6004		-1.85769	65.20
2480	-1.12229	77.2274		-1.82229	65.73
2490	-1.24719	75.0379		-1.94719	63.87
2500	-1.20995	75.6841		-1.90995	64.42

Frequency (MHz)	100mm cable		cable loss	300mm cable	
	Efficiency (dB)	Efficiency (%)		Efficiency (dB)	Efficiency (%)
	X		X-LOSS=Y	Y	
5150	-0.770398	83.7453	0.2*5dB/m	-1.770398	66.52
5180	-0.711782	84.8832		-1.711782	67.43
5210	-0.952011	80.3154		-1.952011	63.80
5240	-1.1463	76.8016		-2.1463	61.01

REVISION: B	ECR/ECN INFORMATION: EC No: ABU2016-0022 DATE: 2015/04/14	TITLE: 2.4/5GHz Balance Antenna (34.9mm*9mm) Application Specification	SHEET No. 8 of 10
DOCUMENT NUMBER: AS-146153-100	CREATED / REVISED BY: Stephen Hu 2015/08/28	CHECKED BY: Chris Zhong 2015/08/28	APPROVED BY: Welson Tan 2015/08/28



APPLICATION SPECIFICATION

5270	-1.14173	76.8824		-2.14173	61.07
5300	-1.22177	75.4784		-2.22177	59.95
5330	-1.08976	77.8079		-2.08976	61.81
5360	-1.15375	76.67		-2.15375	60.90
5390	-1.23326	75.2791		-2.23326	59.80
5420	-0.984162	79.723		-1.984162	63.33
5450	-0.929805	80.7271		-1.929805	64.12
5480	-0.772094	83.7126		-1.772094	66.50
5510	-0.813659	82.9152		-1.813659	65.86
5540	-0.922461	80.8637		-1.922461	64.23
5570	-0.713125	84.857		-1.713125	67.40
5600	-0.584359	87.4106		-1.584359	69.43
5630	-0.321743	92.8594		-1.321743	73.76
5660	-0.644595	86.2066		-1.644595	68.48
5690	-0.739671	84.3399		-1.739671	66.99
5720	-0.818499	82.8228		-1.818499	65.79
5750	-0.913087	81.0385		-1.913087	64.37
5780	-1.2365	75.2229		-2.2365	59.75
5810	-1.18849	76.059		-2.18849	60.42
5840	-1.24776	75.0281		-2.24776	59.60
5850	-1.13398	77.0197		-2.13398	61.18

- The data just for your refer, all performance take chamber testing as accurate.

6.0 ASSEMBLY GUIDELINES

6.0.1 During the assembly of the antenna in a device, the cable needs to be positioned away from the antenna flex. The antenna cable should not go close to the antenna flex. The cable has to be away from the pattern at least 5mm.

REVISION: B	ECR/ECN INFORMATION: EC No: ABU2016-0022 DATE: 2015/04/14	TITLE: 2.4/5GHz Balance Antenna (34.9mm*9mm) Application Specification	SHEET No. 9 of 10
DOCUMENT NUMBER: AS-146153-100	CREATED / REVISED BY: Stephen Hu 2015/08/28	CHECKED BY: Chris Zhong 2015/08/28	APPROVED BY: Welson Tan 2015/08/28

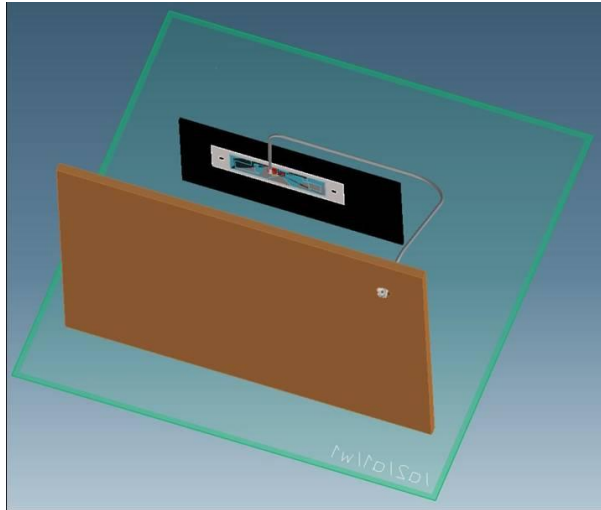

Figure 7

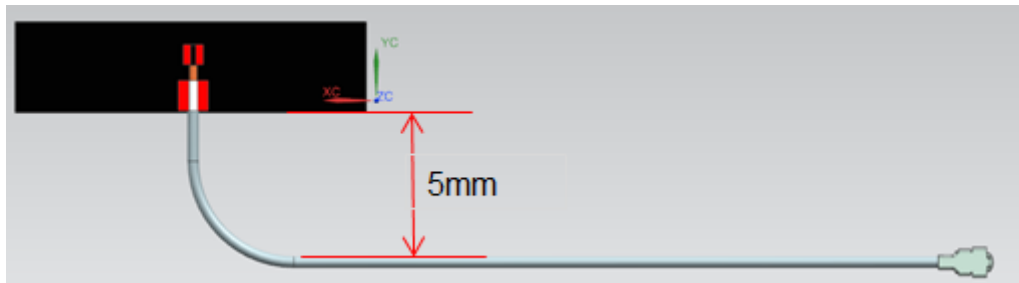

Figure 8

REVISION: B	ECR/ECN INFORMATION: EC No: ABU2016-0022 DATE: 2015/04/14	TITLE: 2.4/5GHz Balance Antenna (34.9mm*9mm) Application Specification	SHEET No. 10 of 10
DOCUMENT NUMBER: AS-146153-100	CREATED / REVISED BY: Stephen Hu 2015/08/28	CHECKED BY: Chris Zhong 2015/08/28	APPROVED BY: Welson Tan 2015/08/28