

LC-R067R2P*1

DIMENSIONS (MM)

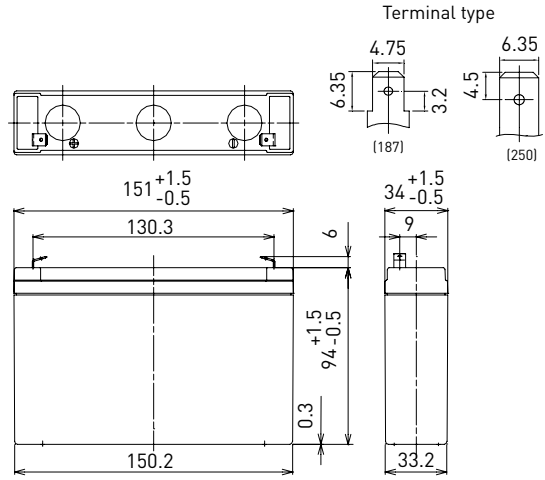

FOR MAIN AND STANDBY POWER SUPPLIES.
EXPECTED TRICKLE DESIGN LIFE: 6 – 9 YEARS AT 20°C
ACCORDING TO EUROBAT.



Contents indicated (including the recycle marking, etc.) are subject to change without notice.

Battery case resin: standard (UL94 HB)

SPECIFICATIONS		LC-R067R2P*1
Name		LC-R067R2P*1
Nominal voltage		6V
Nominal capacity (20 hour rate)		7.2Ah
Dimensions	Length	151mm
	Width	34mm
	Height	100mm
Approx. mass		1.30kg
Terminal		Faston 187/250
Capacity (25°C)	20 hour rate	7.2Ah
	10 hour rate	6.6Ah
	3 hour rate	5.8Ah
	1 hour rate	4.9Ah
Impedance		Fully charged battery (25°C) 11mΩ
Temperature dependency of capacity (20 hour rate)	40°C	102%
	25°C	100%
	0°C	85%
	-15°C	65%
Self-discharge (25°C)	After 3 month	91%
	After 6 month	82%
	After 12 month	64%

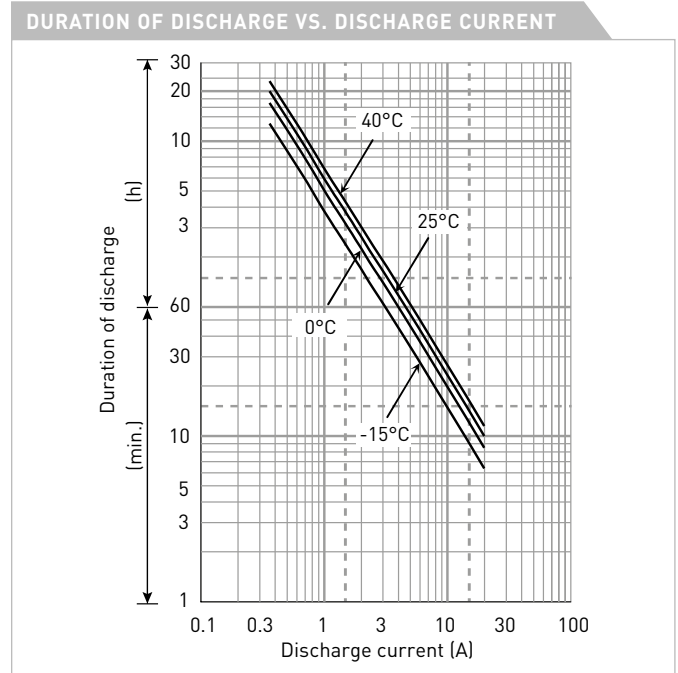

WATT TABLE (25°C)																(Wattage/battery)
Cut-off	3min.	5min.	10min.	15min.	20min.	30min.	45min.	1h	1.5h	2h	3h	4h	5h	6h	10h	20h
4.80V	215	167	110	83.5	67.1	49.2	36.0	28.2	22.3	17.3	12.3	9.60	7.69	6.40	4.19	2.30
4.95V	202	143	93.5	79.5	64.8	48.2	35.8	27.6	21.9	17.2	12.1	9.53	7.63	6.27	4.18	2.29
5.10V	189	136	91.0	75.5	63.0	47.2	34.3	26.8	20.7	16.3	11.8	9.33	7.32	6.11	4.00	2.21
5.25V	172	124	86.8	72.2	60.2	45.4	33.4	26.2	19.9	15.8	11.5	9.15	7.27	6.05	3.98	2.14
5.40V	154	112	82.0	69.1	57.7	43.6	31.3	24.2	18.6	14.0	10.7	8.46	6.67	5.60	3.71	2.07

AMPERE TABLE (25°C)																(Ampere/battery)
Cut-off	3min.	5min.	10min.	15min.	20min.	30min.	45min.	1h	1.5h	2h	3h	4h	5h	6h	10h	20h
4.80V	38.9	30.6	19.9	14.8	12.3	9.10	6.40	5.10	3.50	2.70	2.00	1.53	1.26	1.02	0.670	0.363
4.95V	36.1	28.7	19.5	14.7	12.1	9.00	6.36	5.05	3.43	2.68	1.99	1.52	1.25	1.01	0.667	0.362
5.10V	34.2	26.9	19.0	14.4	11.9	8.90	6.30	5.00	3.36	2.61	1.97	1.51	1.24	1.00	0.660	0.361
5.25V	31.4	24.1	17.6	13.4	11.3	8.70	6.20	4.90	3.29	2.52	1.94	1.50	1.23	0.988	0.657	0.360
5.40V	29.0	22.3	15.7	12.5	11.0	8.40	6.10	4.80	3.20	2.40	1.90	1.48	1.20	0.972	0.650	0.358

All mentioned values are average values

LC-R067R2P*1

CHARGING METHOD (25°C)

Cycle use
Control voltage: 7.25V - 7.45V
Initial current: 2.88A or smaller

CUT-OFF VOLTAGE

Discharge current	0.360A - 1.44A	1.44A - 3.60A	3.60A - 7.20A	7.20A - 14.4A	14.4A - 21.6A
Cut-off voltage	5.25V	5.10V	4.95V	4.65V	4.35V

CYCLE LIFE VS. DEPTH OF DISCHARGE (ACC. IEC 61056)

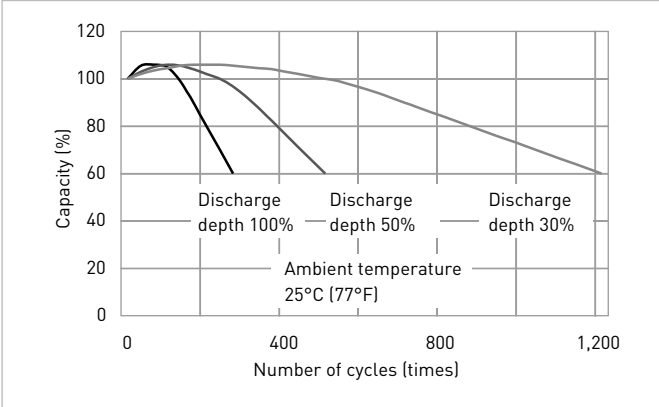

RESIDUAL CAPACITY TEST RESULT

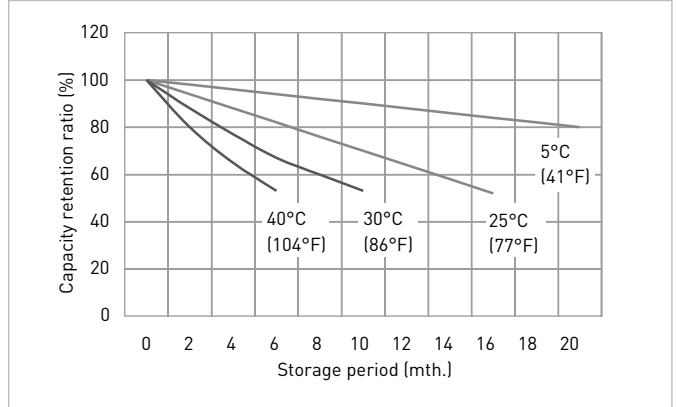

CONSTANT-VOLTAGE CONSTANT-CURRENT CHARGE CHARACTERISTICS FOR CYCLE USE

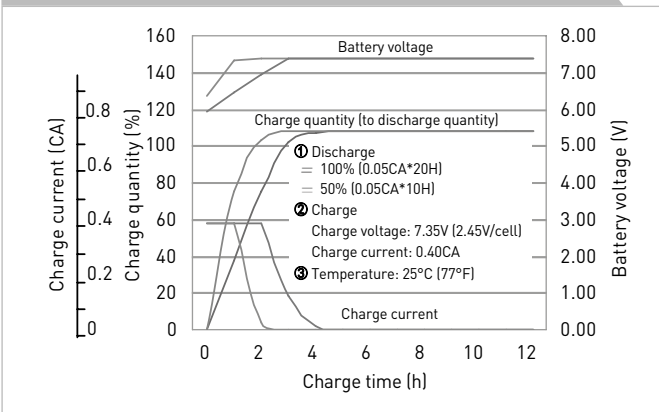

DISCHARGE CAPACITY BY TEMPERATURE AND BY DISCHARGE CURRENT

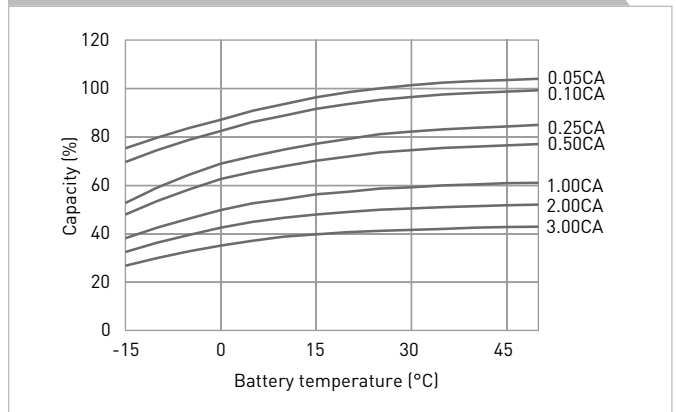

DISCHARGE CHARACTERISTICS

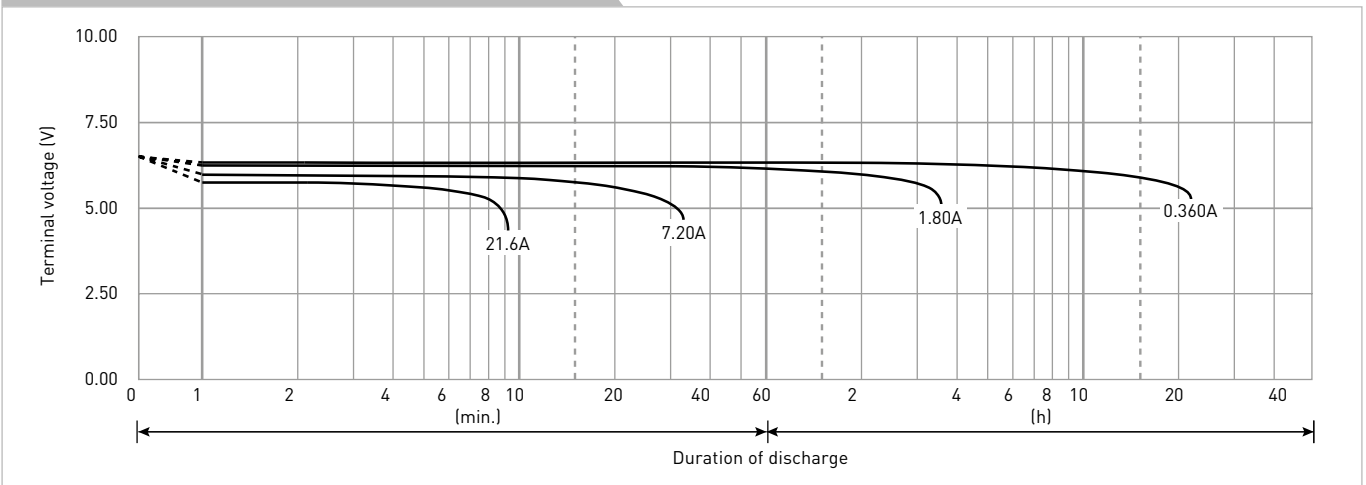

The data in this document are for descriptive purposes only and are not intended to make or imply any guarantee or warranty. Regarding handling and safety please consult our VRLA technical handbook chapter 1.

*1 This battery is also available with a flame retardant battery case resin (UL94 V-0): LC-V067R2P.