

Linear Position Sensor in Hall Effect Technology (0 mm to 10 mm max.)

FEATURES

- Accurate linearity down to: $\pm 1\%$
- Electrical strokes from 0 mm to 10 mm
- Long life: Greater than 10M cycles
- Non contacting technology: Hall effect
- Model dedicated to all applications in harsh environments
- Compliant to RoHS Directive 2002/95/EC

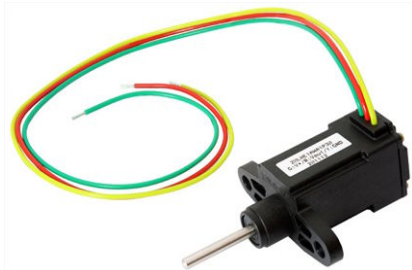

RoHS
COMPLIANT

ELECTRICAL SPECIFICATIONS	
PARAMETER	STANDARD
Electrical stroke	Up to 10 mm
Linearity	$\pm 2\%$ or $\pm 1\%$
Supply voltage	5 V _{DC} $\pm 10\%$
Supply current	< 16 mA typical
Output signal	Analog ratiometric 10 % to 90 % of V _{supply} or PWM 10 % to 90 % duty cycle
Over voltage protection	+ 20 V _{DC}
Reverse voltage protection	- 10 V _{DC}
Load resistance recommended	Min. 1 k Ω for analog output and PWM output
Hysteresis	Static: 0.1 % of V _{supply} /Dynamic: 0.25 % of V _{supply}
Resolution	12 bits

MECHANICAL SPECIFICATIONS	
PARAMETER	
Mechanical travel	12 mm max.
Bearing type	Sleeve bearing
Standard	For spring loaded model: IP 51/without spring: Other on request
Weight	26 g ± 4 g

ORDERING INFORMATION/DESCRIPTION							
20 LHE	1	A	W	A	1P30	xxxx	e1
MODEL	FEATURES	LINEARITY	OUTPUT TYPE	OUTPUT SIGNAL	SHAFT TYPE	SPECIAL REQUEST	LEAD FINISH
	1: Spring return 2: Without spring	X: $\pm 2\%$ A: $\pm 1\%$	W: Wires Z: Custom	A: Analog increasing B: Analog decreasing C: PWM increasing D: PWM decreasing	1: 3.175 mm 9: Special P: Plain T: Threaded M3 x 6 Z: Other type		
Shaft length from mounting face 30 mm when full extended							

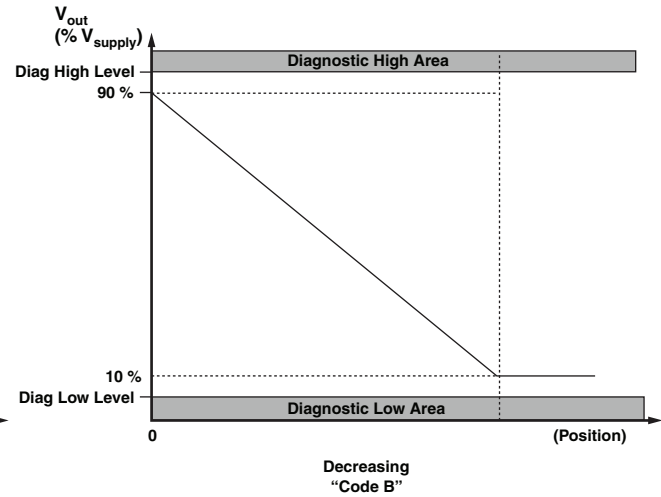
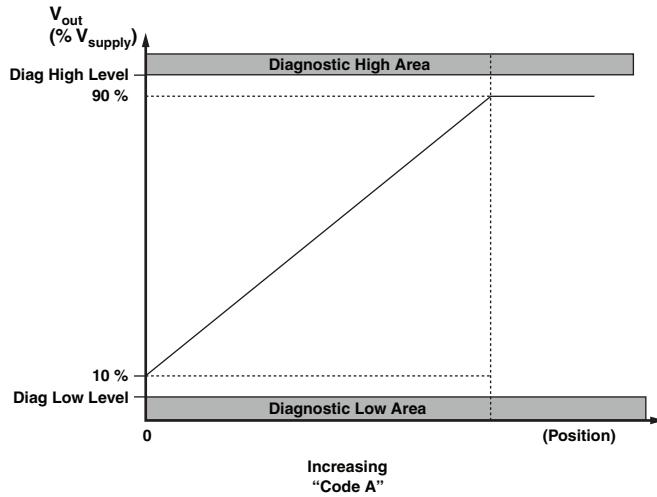
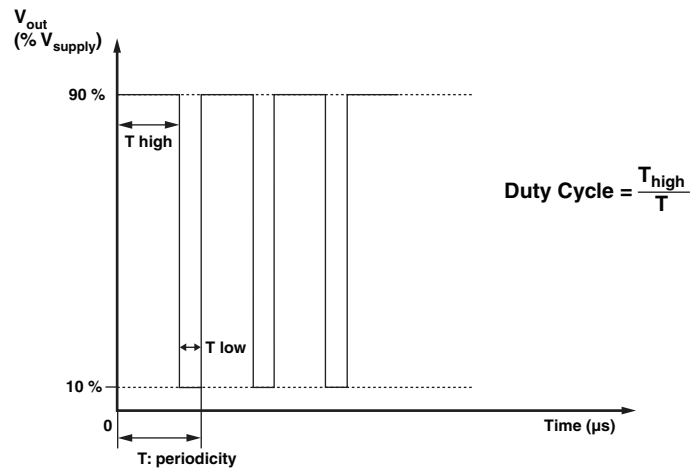
SAP PART NUMBERING GUIDELINES						
20 LHE	2	X	Z	C	1T35	xxxx
MODEL	FEATURES	LINEARITY	OUTPUT TYPE	OUTPUT SIGNAL	SHAFT TYPE	SPECIAL REQUEST
	Without spring return system	$\pm 2\%$	"Custom"	PWM increasing		

V_{OUT} ANALOG

V_{OUT} PWM

ENVIRONMENTAL SPECIFICATIONS	
Vibrations	20 g from 10 Hz to 2000 Hz
Shocks	3 shocks/axis; 50 g half a sine 11 ms
Operating temperature range	- 40 °C; + 85 °C
Life	> 10M of cycles
Speed (max.)	60 mm/s
Immunity to radiated electromagnetic disturbances	200 V/m 150 kHz/1 GHz IEC 62132-2 part 2 (level A)
Immunity to power frequency magnetic field	200 A/m 50 Hz/60 Hz EN 61000-4-8
Radiated electromagnetic emissions	30 MHz/1 GHz < 30 dBµV/m EN 61000-6-4
Electrostatic discharges	Contact discharges: ± 4 kV Air discharges: ± 8 kV EN 61000-4-2
Immunity to radiated RF field	10 V/m 80 MHz to 1 GHz EN6100-4-3

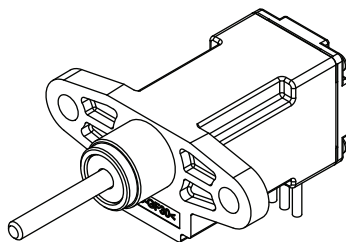
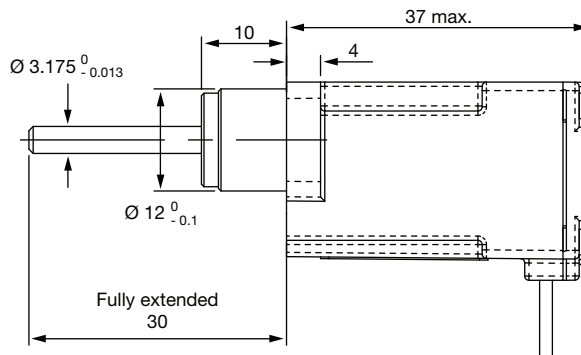
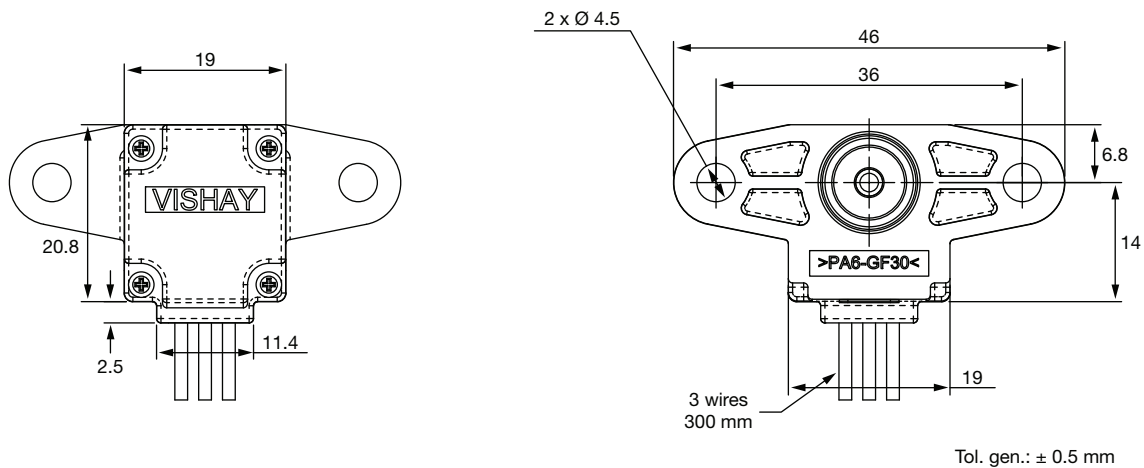
ENVIRONMENTAL SPECIFICATIONS	
Materials	
Housing	Thermoplastic housing
Mounting type	Flange with 2 holes \varnothing 4.5 mm
Shaft	\varnothing 3.175 mm (stainless steel)
Output	3 lead wires (AWG 20) Length: 300 mm
Centering diameter	\varnothing 12 mm
Spring force	From 1.5 N to 7 N along stroke (typical)

DIMENSIONS in millimeters

Wire	
YELLOW	GND (-)
RED	SIGNAL
GREEN	V _{cc} (+)



Disclaimer

ALL PRODUCT, PRODUCT SPECIFICATIONS AND DATA ARE SUBJECT TO CHANGE WITHOUT NOTICE TO IMPROVE RELIABILITY, FUNCTION OR DESIGN OR OTHERWISE.

Vishay Intertechnology, Inc., its affiliates, agents, and employees, and all persons acting on its or their behalf (collectively, "Vishay"), disclaim any and all liability for any errors, inaccuracies or incompleteness contained in any datasheet or in any other disclosure relating to any product.

Vishay makes no warranty, representation or guarantee regarding the suitability of the products for any particular purpose or the continuing production of any product. To the maximum extent permitted by applicable law, Vishay disclaims (i) any and all liability arising out of the application or use of any product, (ii) any and all liability, including without limitation special, consequential or incidental damages, and (iii) any and all implied warranties, including warranties of fitness for particular purpose, non-infringement and merchantability.

Statements regarding the suitability of products for certain types of applications are based on Vishay's knowledge of typical requirements that are often placed on Vishay products in generic applications. Such statements are not binding statements about the suitability of products for a particular application. It is the customer's responsibility to validate that a particular product with the properties described in the product specification is suitable for use in a particular application. Parameters provided in datasheets and/or specifications may vary in different applications and performance may vary over time. All operating parameters, including typical parameters, must be validated for each customer application by the customer's technical experts. Product specifications do not expand or otherwise modify Vishay's terms and conditions of purchase, including but not limited to the warranty expressed therein.

Except as expressly indicated in writing, Vishay products are not designed for use in medical, life-saving, or life-sustaining applications or for any other application in which the failure of the Vishay product could result in personal injury or death. Customers using or selling Vishay products not expressly indicated for use in such applications do so at their own risk and agree to fully indemnify and hold Vishay and its distributors harmless from and against any and all claims, liabilities, expenses and damages arising or resulting in connection with such use or sale, including attorneys fees, even if such claim alleges that Vishay or its distributor was negligent regarding the design or manufacture of the part. Please contact authorized Vishay personnel to obtain written terms and conditions regarding products designed for such applications.

No license, express or implied, by estoppel or otherwise, to any intellectual property rights is granted by this document or by any conduct of Vishay. Product names and markings noted herein may be trademarks of their respective owners.