

Description

The 74LVC32A provides four independent 2-input OR gates. The device is designed for operation with a power supply range of 1.65V to 3.6V. The inputs are tolerant to 5.5V allowing this device to be used in a mixed voltage environment. The device is fully specified for partial power down applications using IOFF. The IOFF circuitry disables the output preventing damaging current backflow when the device is powered down.

The gates perform the positive Boolean function:

$$Y = A + B \text{ or } Y = \overline{\overline{A} \cdot \overline{B}}$$

Features

- Supply Voltage Range from 1.65V to 3.6V
- Sinks 24mA at $V_{CC} = 3.3V$
- CMOS low power consumption
- IOFF Supports Partial-Power-Down Mode Operation
- Inputs or outputs accept up to 5.5V
- Inputs can be driven by 3.3V or 5.5V allowing for voltage translation applications.
- ESD Protection Exceeds JESD 22
 - 200-V Machine Model (A115-A)
 - 2000-V Human Body Model (A114-A)
- Latch-Up Exceeds 250mA per JESD 78, Class II
- Range of Package Options SO-14 and TSSOP-14
- **Totally Lead-Free & Fully RoHS Compliant (Notes 1 & 2)**
- **Halogen and Antimony Free. "Green" Device (Note 3)**

- Notes:
1. No purposely added lead. Fully EU Directive 2002/95/EC (RoHS) & 2011/65/EU (RoHS 2) compliant.
 2. See <http://www.diodes.com> for more information about Diodes Incorporated's definitions of Halogen- and Antimony-free, "Green" and Lead-free.
 3. Halogen- and Antimony-free "Green" products are defined as those which contain <900ppm bromine, <900ppm chlorine (<1500ppm total Br + Cl) and <1000ppm antimony compounds.

Pin Assignments

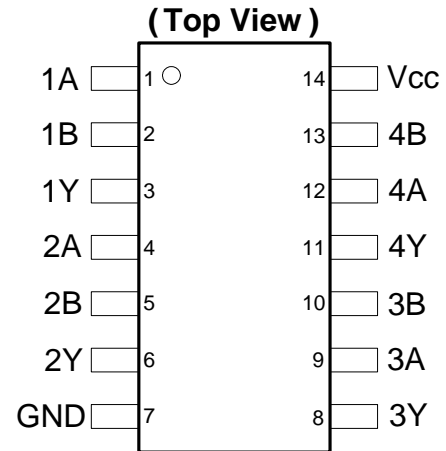

SO-14 / TSSOP-14

Applications

- Voltage Level Shifting
- General Purpose Logic
- Power Down Signal Isolation
- Wide array of products such as:
 - PCs, networking, notebooks, ultrabooks, netbooks, PDAs
 - Computer peripherals, hard drives, CD/DVD ROM
 - TV, DVD, DVR, set top box

Pin Descriptions

Pin Number	Pin Name	Description
1	1A	Data Input
2	1B	Data Input
3	1Y	Data Output
4	2A	Data Input
5	2B	Data Input
6	2Y	Data Output
7	GND	Ground
8	3Y	Data Output
9	3A	Data Input
10	3B	Data Input
11	4Y	Data Output
12	4A	Data Input
13	4B	Data Input
14	V _{CC}	Supply Voltage

Logic Diagram

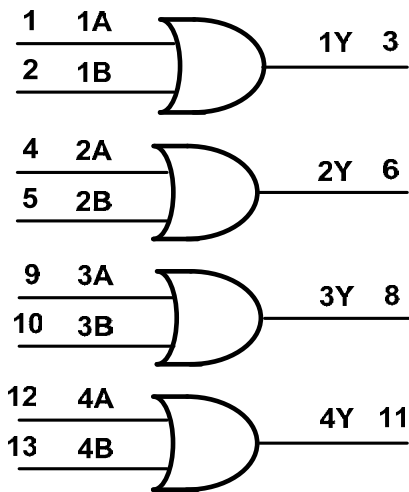

Function Table

Inputs		Output
A	B	Y
L	L	L
L	H	H
H	L	H
H	H	H

Absolute Maximum Ratings (Note 4) (@T_A = +25°C, unless otherwise specified.)

Symbol	Description	Rating	Unit
ESD HBM	Human Body Model ESD Protection	2	KV
ESD MM	Machine Model ESD Protection	200	V
V _{CC}	Supply Voltage Range	-0.5 to 6.5	V
V _I	Input Voltage Range	-0.5 to 6.5	V
V _O	Voltage applied to output in high impedance or I _{OFF} state	-0.5 to 6.5	V
V _O	Voltage applied to output in high or low state	-0.3 to V _{CC} +0.5	V
I _{IK}	Input Clamp Current V _I < 0	-50	mA
I _{OK}	Output Clamp Current V _O < 0	-50	mA
I _O	Continuous output current	±50	mA
I _{CC} , I _{GND}	Continuous current through V _{CC} or GND	±100	mA
T _J	Operating Junction Temperature	-40 to +150	°C
T _{STG}	Storage Temperature	-65 to +150	°C
P _{TOT}	Total Power Dissipation	500	mW

Note: 4. Stresses beyond the absolute maximum may result in immediate failure or reduced reliability. These are stress values and device operation should be within recommend values.

Recommended Operating Conditions (Note 5) (@T_A = +25°C, unless otherwise specified.)

Symbol	Parameter	Conditions	Min	Max	Unit
V _{CC}	Supply Voltage		1.65	3.6	V
V _I	Input Voltage		0	5.5	V
V _O	Output Voltage	Active Mode	0	V _{CC}	V
		V _{CC} = 0V; Power Down Mode	0	5.5	
Δt/ΔV	Input transition rise or fall rate	V _{CC} = 1.65V to 2.7V		20	ns/V
		V _{CC} = 2.7V to 3.6V		10	
T _A	Operating free-air temperature		-40	+125	°C

Note: 5. Unused inputs should be held at V_{CC} or Ground.

Electrical Characteristics (@T_A = +25°C, unless otherwise specified.)

Symbol	Parameter	Test Conditions	V _{CC}	T _A = -40°C to +85°C		T _A = -40°C to +125°C		Unit
				Min	Max	Min	Max	
V _{IH}	High-level Input Voltage		1.65V to 1.95V	0.65 X V _{CC}		0.65 X V _{CC}		V
			2.3V to 2.7V	1.7		1.6		
			2.7 V to 3.6V	2.0		2.0		
V _{IL}	Low-level input voltage		1.65V to 1.95V		0.35 X V _{CC}		0.35 X V _{CC}	V
			2.3V to 2.7V		0.7		0.7	
			2.7V to 3.6V		0.8		0.8	
V _{OH}	High Level Output Voltage	I _{OH} = -100μA	1.65V to 3.6V	V _{CC} - 0.2		V _{CC} - 0.3		V
		I _{OH} = -4mA	1.65V	1.2				
		I _{OH} = -8mA	2.3V	1.9				
		I _{OH} = -12mA	2.7V	2.2		2.05		
			3.0V	2.3		2.1		
I _{OH} = -24mA	3.0V	2.2		2.0				
V _{OL}	High-level Output Voltage	I _{OH} = 100μA	1.65V to 3.6V		0.2		0.3	V
		I _{OH} = 4mA	1.65V		0.45		0.6	
		I _{OH} = 8mA	2.3V		0.70		0.85	
		I _{OH} = 12mA	2.7V		0.40		0.6	
			3.0V		0.55		0.6	
I _{OH} = -24mA	3.0V		0.55		0.6			
I _I	Input Current	V _I = GND to 5.5V	3.6V		± 5		± 20	μA
I _{OFF}	Power Down Leakage Current	V _I or V _O = 0V to 3.6V	0		10		20	μA
I _{CC}	Supply Current	V _I = GND or V _{CC} I _O = 0	3.6V		10		40	μA
ΔI _{CC}	Additional Supply Current	One input at V _{CC} - 0.6V Other at V _{CC} or Gnd.	2.7V to 3.6V		500		5000	μA

Switching Characteristics

Symbol	Parameter	Test Conditions	V _{CC}	T _A = +25°C			-40°C to +85°C		-40°C to +125°C		Unit
				Min	Typ.	Max	Min	Max	Min	Max	
t _{PD}	Propagation Delay A _N or B _N to Y _N	Figure 2	1.65V to 1.95V	1.0	4.2	8.2	1.0	8.7	1.0	10.2	ns
			2.3V to 2.7V	1.0	3.6	4.9	1.0	5.4	1.0	6.9	
			2.7V	1.0	3.0	4.6	1.0	4.9	1.0	5.5	
			3.V to 3.6V	1.0	2.5	4.1	1.0	4.2	1.0	5.0	
t _{SK(0)}	Output Skew Time		3.V to 3.6V					1.0		1.5	ns

Operating Characteristics (@T_A = +25°C, unless otherwise specified.)

Parameter		Test Conditions	V _{CC} = 1.8V	V _{CC} = 2.5V	V _{CC} = 3.3V	Unit
			Typ	Typ	Typ	
C _{pd}	Power dissipation capacitance per gate	f = 10 MHz	7.4	10.5	12.4	pF
C _i	Input Capacitance	V _i = V _{CC} – or GND	4	4	4	pF

Package Characteristics

Symbol	Parameter	Test Conditions	V _{CC}	Min	Typ	Max	Unit
θ _{JA}	Thermal Resistance Junction-to-Ambient	SO-14	(Note 6)		TBD		°C/W
		TSSOP-14			159		
θ _{JC}	Thermal Resistance Junction-to-Case	SO-14	(Note 6)		TBD		°C/W
		TSSOP-14			25		

Note: 6. Test condition for SO-14 and TSSOP-14: Device mounted on FR-4 substrate PC board, 2oz copper, with minimum recommended pad layout.

Parameter Measurement Information

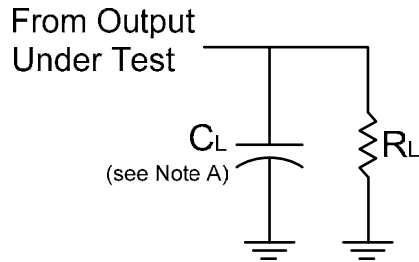

V _{CC}	Inputs		V _M	C _L	R _L
	V _I	t _r /t _f			
1.8V±0.15V	V _{CC}	≤2ns	V _{CC} /2	30pF	1KΩ
2.5V±0.2V	V _{CC}	≤2ns	V _{CC} /2	30pF	500Ω
2.7V	2.7V	≤2.5ns	1.5V	50pF	500Ω
3.3V±0.3V	2.7V	≤2.5ns	1.5V	50pF	500Ω

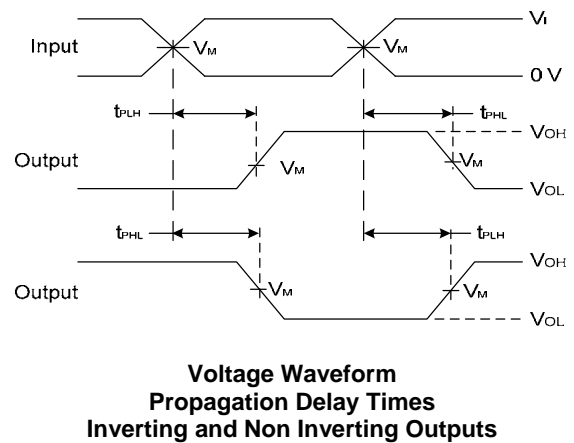
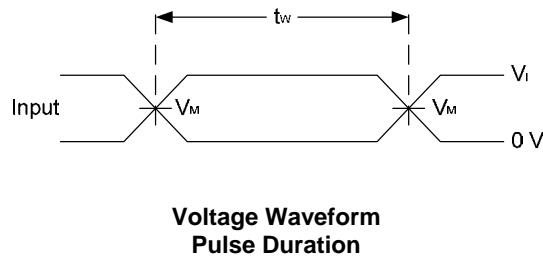
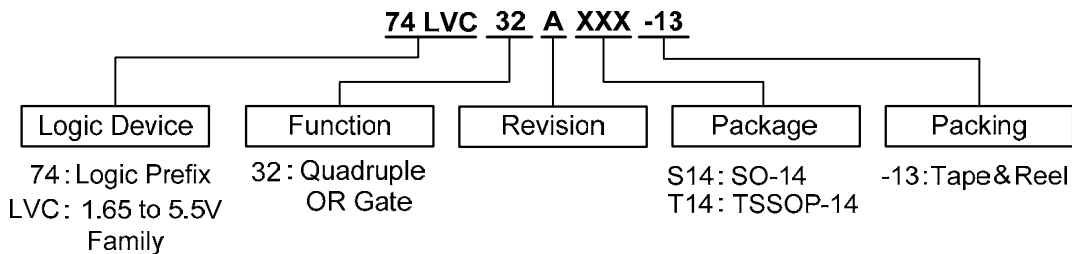

Figure 1. Load Circuit and Voltage Waveforms

- Notes: A. Includes test lead and test apparatus capacitance.
- B. All pulses are supplied at pulse repetition rate ≤ 10 MHz
- C. Inputs are measured separately one transition per measurement
- D. t_{PLH} and t_{PHL} are the same as t_{PD}

Ordering Information



Device	Package Code	Packaging (Note 7)	13" Tape and Reel	
			Quantity	Part Number Suffix
74LVC32AB-13	B	SO-14	2500/Tape & Reel	-13
74LVC32ATS-13**	TS	TSSOP-14	2500/Tape & Reel	-13

Notes: 7. The taping orientation and tape details can be found at <http://www.diodes.com/datasheets/ap02007.pdf>

Marking Information

(1) SO-14, TSSOP-14

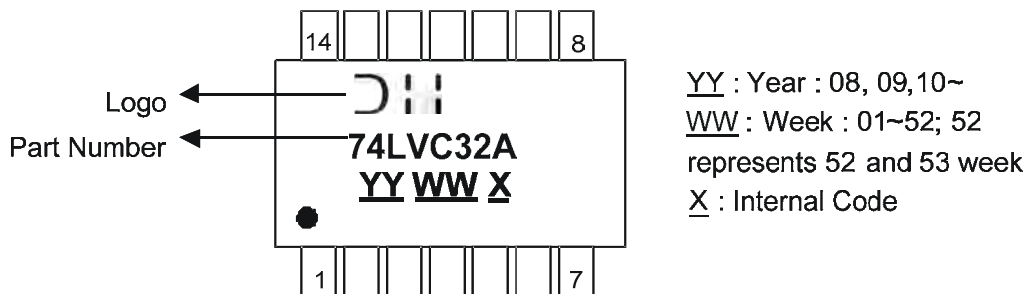

Part Number	Package
74LVC32AB	SO-14
74LVC32ATS**	TSSOP-14

Package Outline Dimensions (All dimensions in mm.)

Package Type: SO-14

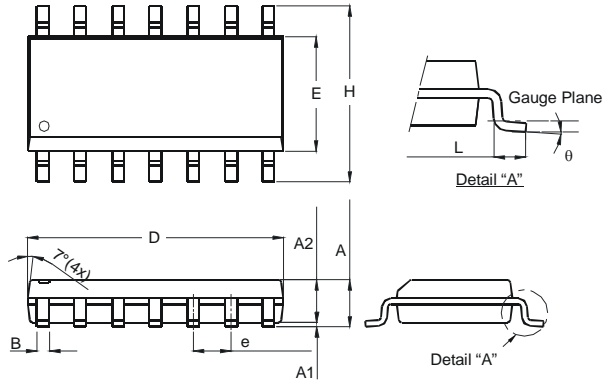

SO-14		
Dim	Min	Max
A	1.47	1.73
A1	0.10	0.25
A2	1.45 Typ	
B	0.33	0.51
D	8.53	8.74
E	3.80	3.99
e	1.27 Typ	
H	5.80	6.20
L	0.38	1.27
θ	0°	8°
All Dimensions in mm		

Package Type: TSSOP-14

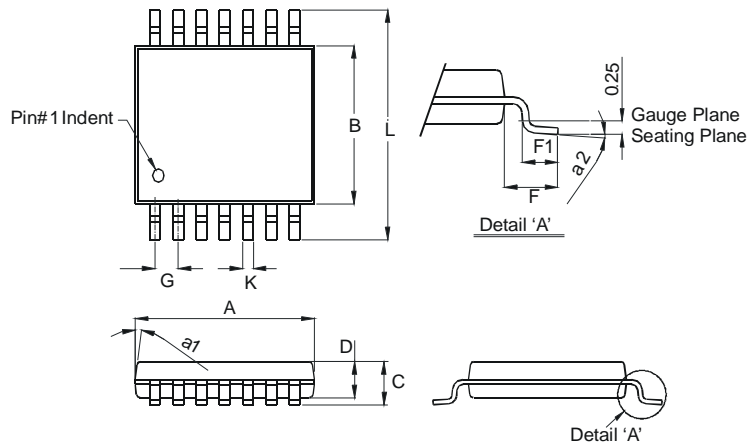

TSSOP-14		
Dim	Min	Max
a1	7° (4X)	
a2	0°	8°
A	4.9	5.10
B	4.30	4.50
C	—	1.2
D	0.8	1.05
F	1.00 Typ	
F1	0.45	0.75
G	0.65 Typ	
K	0.19	0.30
L	6.40 Typ	
All Dimensions in mm		

Suggested Pad Layout

Package Type: SO-14

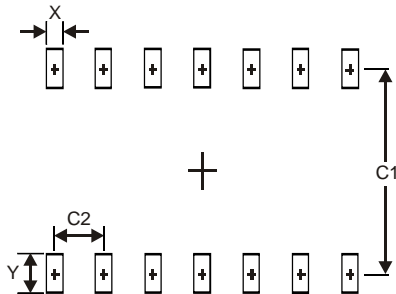

Dimensions	Value (in mm)
X	0.60
Y	1.50
C1	5.4
C2	1.27

Package Type: TSSOP-14

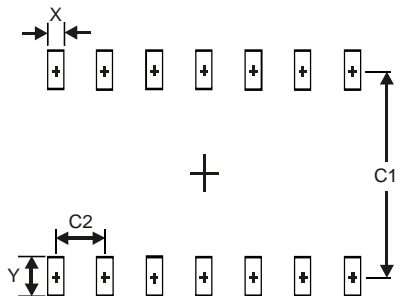

Dimensions	Value (in mm)
X	0.45
Y	1.45
C1	5.9
C2	0.65

IMPORTANT NOTICE

DIODES INCORPORATED MAKES NO WARRANTY OF ANY KIND, EXPRESS OR IMPLIED, WITH REGARDS TO THIS DOCUMENT, INCLUDING, BUT NOT LIMITED TO, THE IMPLIED WARRANTIES OF MERCHANTABILITY AND FITNESS FOR A PARTICULAR PURPOSE (AND THEIR EQUIVALENTS UNDER THE LAWS OF ANY JURISDICTION).

Diodes Incorporated and its subsidiaries reserve the right to make modifications, enhancements, improvements, corrections or other changes without further notice to this document and any product described herein. Diodes Incorporated does not assume any liability arising out of the application or use of this document or any product described herein; neither does Diodes Incorporated convey any license under its patent or trademark rights, nor the rights of others. Any Customer or user of this document or products described herein in such applications shall assume all risks of such use and will agree to hold Diodes Incorporated and all the companies whose products are represented on Diodes Incorporated website, harmless against all damages.

Diodes Incorporated does not warrant or accept any liability whatsoever in respect of any products purchased through unauthorized sales channel. Should Customers purchase or use Diodes Incorporated products for any unintended or unauthorized application, Customers shall indemnify and hold Diodes Incorporated and its representatives harmless against all claims, damages, expenses, and attorney fees arising out of, directly or indirectly, any claim of personal injury or death associated with such unintended or unauthorized application.

Products described herein may be covered by one or more United States, international or foreign patents pending. Product names and markings noted herein may also be covered by one or more United States, international or foreign trademarks.

LIFE SUPPORT

Diodes Incorporated products are specifically not authorized for use as critical components in life support devices or systems without the express written approval of the Chief Executive Officer of Diodes Incorporated. As used herein:

A. Life support devices or systems are devices or systems which:

1. are intended to implant into the body, or
2. support or sustain life and whose failure to perform when properly used in accordance with instructions for use provided in the labeling can be reasonably expected to result in significant injury to the user.

B. A critical component is any component in a life support device or system whose failure to perform can be reasonably expected to cause the failure of the life support device or to affect its safety or effectiveness.

Customers represent that they have all necessary expertise in the safety and regulatory ramifications of their life support devices or systems, and acknowledge and agree that they are solely responsible for all legal, regulatory and safety-related requirements concerning their products and any use of Diodes Incorporated products in such safety-critical, life support devices or systems, notwithstanding any devices- or systems-related information or support that may be provided by Diodes Incorporated. Further, Customers must fully indemnify Diodes Incorporated and its representatives against any damages arising out of the use of Diodes Incorporated products in such safety-critical, life support devices or systems.

Copyright © 2012, Diodes Incorporated

www.diodes.com