



AL460A-EVB-A0 Evaluation Board with HSMC Adaptor

User Manual *Version 1.0*

(AL460A-7-EVB-A0 / AL460A-13-EVB-A0)

INFORMATION FURNISHED BY AVERLOGIC IS BELIEVED TO BE ACCURATE AND RELIABLE. HOWEVER, NO RESPONSIBILITY IS ASSUMED BY AVERLOGIC FOR ITS USE, NOR FOR ANY INFRINGEMENTS OF PATENTS OR OTHER RIGHTS OF THIRD PARTIES THAT MAY RESULT FROM ITS USE. NO LICENSE IS GRANTED BY IMPLICATION OR OTHERWISE UNDER ANY PATENT OR PATENT RIGHTS OF AVERLOGIC.

Doc Number: 1-M-PAE262-0001

Amendments

Revise Date	Contents	Author
2010.08.13	Formal Release Version 1.0	Ray Pan

Disclaimer

THE CONTENTS OF THIS DOCUMENT ARE SUBJECT TO CHANGE WITHOUT NOTICE. AVERLOGIC TECHNOLOGIES RESERVES THE RIGHT TO MAKE CHANGES WITHOUT FURTHER NOTICE TO ANY PRODUCTS HEREIN TO IMPROVE RELIABILITY, FUNCTION OR DESIGN. AVERLOGIC DOES NOT ASSUME ANY LIABILITY ARISING OUT OF THE APPLICATION OR USE OF ANY PRODUCT OR CIRCUIT DESCRIBED HEREIN; NEITHER DOES IT CONVEY ANY LICENSE UNDER ITS PATENT RIGHTS, NOR THE RIGHTS OF OTHERS. CUSTOMERS ARE ADVISED TO CONSULT WITH AVERLOGIC OR ITS COMMERCIAL DISTRIBUTORS BEFORE ORDERING.

Table of Contents

1 INTRODUCTION.....	4
2 ADAPTOR INTERFACE.....	5
2.1 ALTERA CYCLONE III INTERFACE – HSMC CONNECTOR.....	5
2.2 AL460 EVALUATION BOARD INTERFACE – 50-PIN HEADERS.....	7
2.3 USER CONTROL INTERFACE.....	8
3 ATTACHING THE AL460 EVB.....	9

1 Introduction

The AL460 HSMC Adaptor (BB-AL460FSB1-EVB-D0) is designed for connecting the AL460 module (DST-0106A-MDL-A0/A1) to an ALTERA Cyclone III FPGA board. This configuration facilitates design verification/validation when developing or testing with the AL460 chip.

This adaptor provides one HSMC connector for the FGPA board and two 50-pin female headers for the AL460 module board (DST-0106A-MDL-A0/A1). The HSMC connector is a modified version of a standard high-speed Samtec connector, which is pin-to-pin compatible with the Cyclone III FPGA host board's HSMC connector. The 50-pin female headers match the two male headers on the AL460 module (DST-0106A-MDL-A0/A1).

1.1 Hardware Description

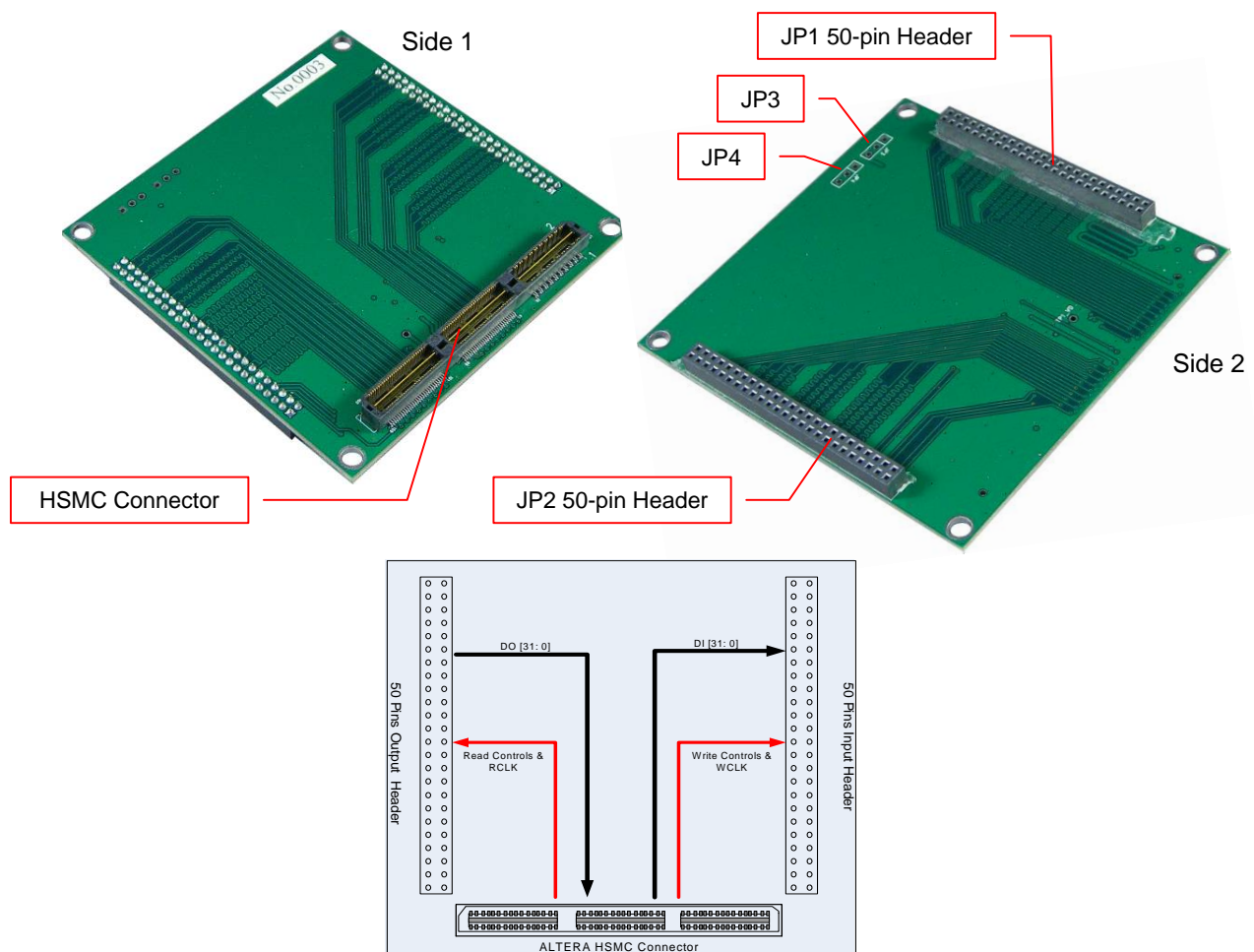

Figure: AL460 HSMC Adaptor

2 Adaptor Interface

2.1 Altera Cyclone III Interface – HSMC connector

The HSMC connector reference part numbers are listed in the table directly below. The HSMC reference label on the adaptor board is J1.

Altera-Specific Samtec Part Number	Standard Samtec Part Number
ASP-122952-01	QTH-090-01-L-D-A

Table: HSMC Part Numbers

The user interface between the evaluation board and the HSMC connector is shown in the Pin Description table below. The “HSMC I/O type” refers to the I/O capability of the Cyclone III device from Altera.

AL460 Signal Name	HSMC signal name	HSMC I/O type	Pin Number
AL460_RSTN	HSMC_CLKOUT0	O	39
RRST	HSMC_D0	Bidirectional	41
OE	HSMC_D1	Bidirectional	42
REN	HSMC_D2	Bidirectional	43
DO[0]	HSMC_D3	Bidirectional	44
DO[1]	HSMC_D4	Bidirectional	47
DO[2]	HSMC_D5	Bidirectional	48
DO[3]	HSMC_D6	Bidirectional	49
DO[4]	HSMC_D7	Bidirectional	50
DO[5]	HSMC_D8	Bidirectional	53
DO[6]	HSMC_D9	Bidirectional	54
DO[7]	HSMC_D10	Bidirectional	55
DO[8]	HSMC_D11	Bidirectional	56
DO[9]	HSMC_D12	Bidirectional	59
DO[10]	HSMC_D13	Bidirectional	60
DO[11]	HSMC_D14	Bidirectional	61
DO[12]	HSMC_D15	Bidirectional	62
DO[13]	HSMC_D16	Bidirectional	65
DO[14]	HSMC_D17	Bidirectional	66
DO[15]	HSMC_D18	Bidirectional	67
DO[16]	HSMC_D19	Bidirectional	68
DO[17]	HSMC_TX_p4	Bidirectional	71
DO[18]	HSMC_RX_p4	Bidirectional	72
DO[19]	HSMC_TX_n4	Bidirectional	73
DO[20]	HSMC_RX_n4	Bidirectional	74
DO[21]	HSMC_TX_p5	Bidirectional	77
DO[22]	HSMC_RX_p5	Bidirectional	78
DO[23]	HSMC_TX_n5	Bidirectional	79
DO[24]	HSMC_RX_n5	Bidirectional	80
DO[25]	HSMC_TX_p6	Bidirectional	83
DO[26]	HSMC_RX_p6	Bidirectional	84

DO[27]	HSMC_TX_n6	Bidirectional	85
DO[28]	HSMC_RX_n6	Bidirectional	86
DO[29]	HSMC_TX_p7	Bidirectional	89
DO[30]	HSMC_RX_p7	Bidirectional	90
DO[31]	HSMC_TX_n7	Bidirectional	91
RCLKO_INV	HSMC_RX_n7	Bidirectional	92
RCLK	HSMC_CLKOUT_p1	O	95
RCLKO_EN	HSMC_CLKOUT_n1	O	97
RCLK_OUT	HSMC_CLKIN_n1	I	98
RD_FRAME_SEL	HSMC_TX_p8	Bidirectional	101
WRST	HSMC_RX_p8	Bidirectional	102
IE	HSMC_TX_n8	Bidirectional	103
WEN	HSMC_RX_n8	Bidirectional	104
DI[31]	HSMC_TX_p9	Bidirectional	107
DI[30]	HSMC_RX_p9	Bidirectional	108
DI[29]	HSMC_TX_n9	Bidirectional	109
DI[28]	HSMC_RX_n9	Bidirectional	110
DI[27]	HSMC_TX_p10	Bidirectional	113
DI[26]	HSMC_RX_p10	Bidirectional	114
DI[25]	HSMC_TX_n10	Bidirectional	115
DI[24]	HSMC_RX_n10	Bidirectional	116
DI[23]	HSMC_TX_p11	Bidirectional	119
DI[22]	HSMC_RX_p11	Bidirectional	120
DI[21]	HSMC_TX_n11	Bidirectional	121
DI[20]	HSMC_RX_n11	Bidirectional	122
DI[19]	HSMC_TX_p12	Bidirectional	125
DI[18]	HSMC_RX_p12	Bidirectional	126
DI[17]	HSMC_TX_n12	Bidirectional	127
DI[16]	HSMC_RX_n12	Bidirectional	128
DI[15]	HSMC_TX_p13	Bidirectional	131
DI[14]	HSMC_RX_p13	Bidirectional	132
DI[13]	HSMC_TX_n13	Bidirectional	133
DI[12]	HSMC_RX_n13	Bidirectional	134
DI[11]	HSMC_TX_p14	Bidirectional	137
DI[10]	HSMC_RX_p14	Bidirectional	138
DI[9]	HSMC_TX_n14	Bidirectional	139
DI[8]	HSMC_RX_n14	Bidirectional	140
DI[7]	HSMC_TX_p15	Bidirectional	143
DI[6]	HSMC_RX_p15	Bidirectional	144
DI[5]	HSMC_TX_n15	Bidirectional	145
DI[4]	HSMC_RX_n15	Bidirectional	146
DI[3]	HSMC_TX_p16	Bidirectional	149
DI[2]	HSMC_RX_p16	Bidirectional	150
DI[1]	HSMC_TX_n16	Bidirectional	151
DI[0]	HSMC_RX_n16	Bidirectional	152
WCLK	HSMC_CLKOUT_p2	O	155
WR_FRAME_SEL	HSMC_OUT_n2	O	157

Table: HSMC Pin Description

The HSMC connector pin-map for the adaptor is illustrated in the figure below.

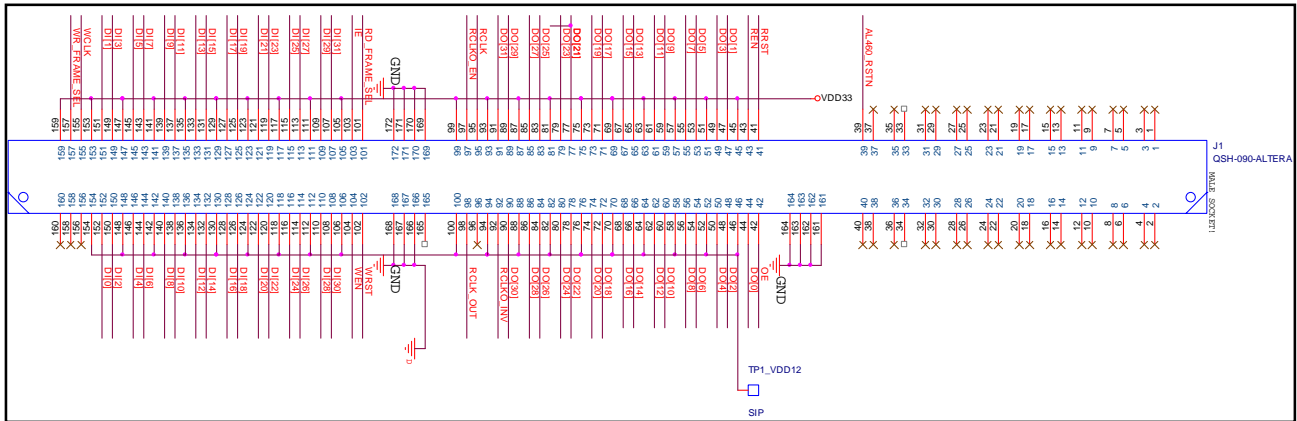

Figure: HSMC Connector Pin-Map.

2.2 AL460 Evaluation Board Interface – 50-pin Headers

Two 25x2 female headers (2.0 mm pitch) are embedded into the adaptor and are used to connect to the DST-0106A-MDL-A0/A1 module board. The pin-maps for the two headers are shown in the figure below.

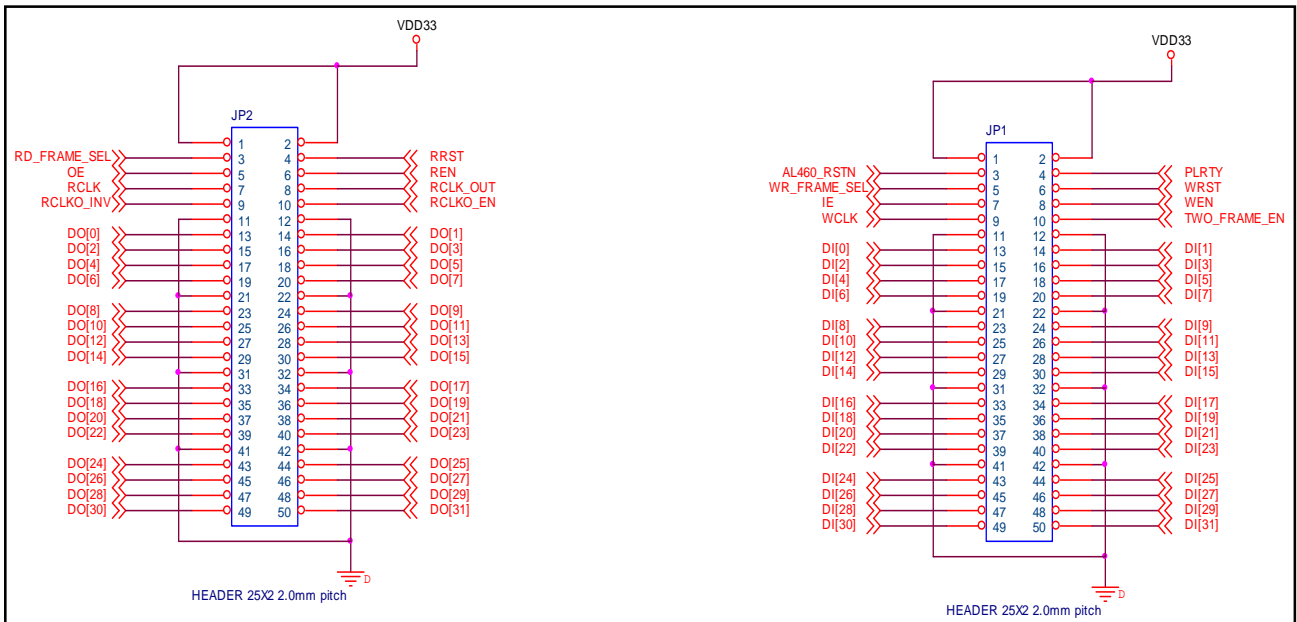

Figure: Two 50-Pin Header Pin-Map

2.3 User Control Interface

When connecting the AL460 evaluation board, the functions “Two Frame Mode” and “Polarity Control” are configured on two 3-pin headers (JP3 & JP4 on adaptor).

Pin name	I/O type	Description
PLRITY	I	<p>Set the active polarity for the control signals by jumpering pins 1,2, 3 on JP4:</p> <ul style="list-style-type: none"> ■ Jumper 2, 3: PLRITY is active low (VD33). ■ Jumper 1, 2: PLRITY is active high (GND). <p>Control signals include WEN, REN, WRST, RRST, IE, OE, (total of 6 signals).</p> <p>Note: During memory operations, the pin must be permanently connected to VD33 or GND. If PLRITY level is changed during a memory operation, memory data is not guaranteed.</p>
TWO_FRAME_EN	I	<p>Set Two Frame Mode by jumpering pins 1,2 3 on JP3:</p> <ul style="list-style-type: none"> ■ Jumper 1,2: “0” – Standard FIFO Mode ■ Jumper 3,2: “1” – Two Frame Mode

Note: These signals are internally pull-high; default is high if signals are NC.

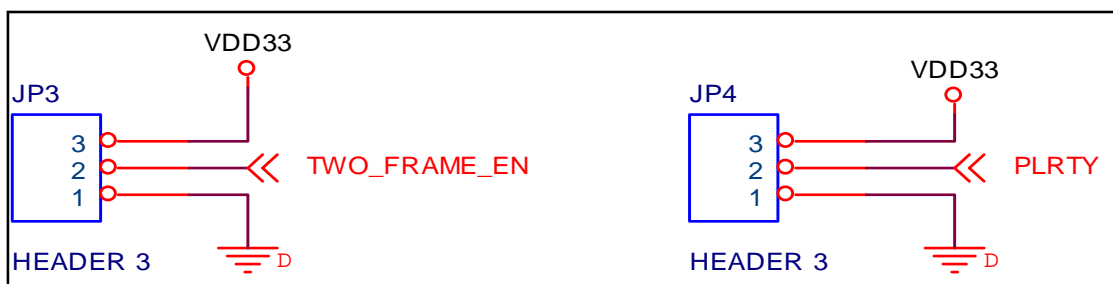

Figure: 3-Pin Header Pin-Map

3 Attaching the AL460 EVB

The HSMC adaptor shares the same dimensions as the DST-0106A-MDL-A0/A1 (80 mm x 80 mm) and should align perfectly when connected together. Match the pins on the male connectors (on module board) to the female connectors (on Adaptor) as follows:

AL460A HSMC Adaptor (BB-AL460FSB1-D0)	AL460A Module (DST-0106A-MDL-A0/A1)
JP1	JP2
JP2	JP1

(i.e. the JP1 connector on the Adaptor attaches to the JP2 connector on the EVB. The JP2 connector on the Adaptor attaches to the JP1 connector on the EVB).

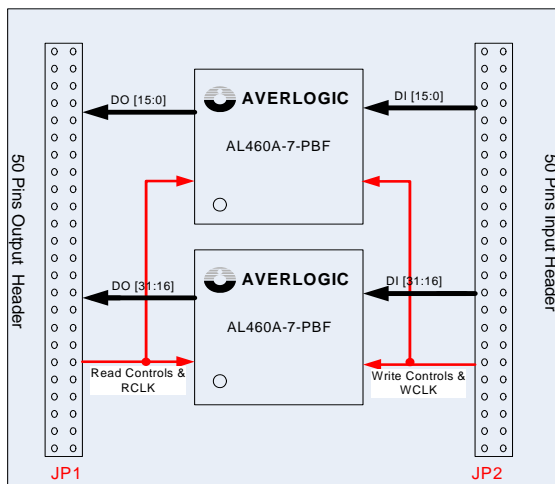
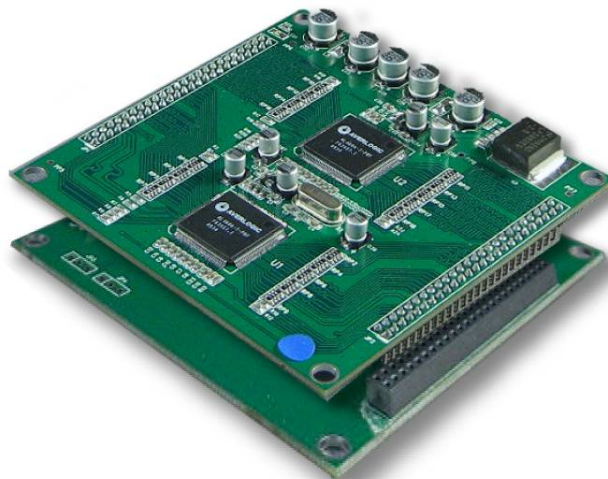

Figure: AL460 Module Diagram

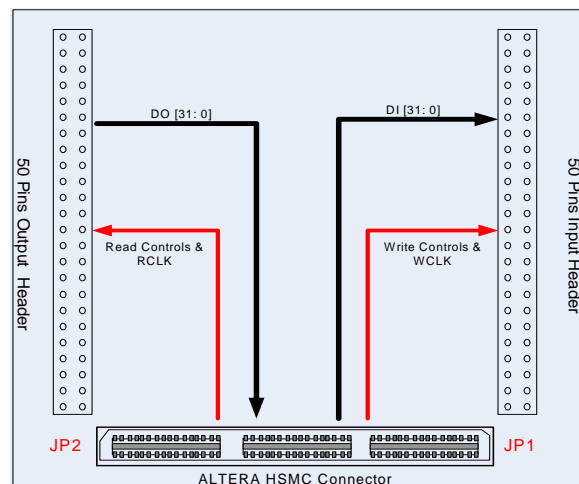

Figure: AL460 HSMC adaptor Board

CONTACT INFORMATION

Averlogic Technologies Corp.
E-mail: sales@averlogic.com
URL: <http://www.averlogic.com>