

## Encoder WDG 58B



- Rugged industrial standard encoder
- Up to 25000 PPR by use of high grad electronics
- Protection to IP67, shaft sealed to IP65
- Maximum mechanical and electrical safety
- Full connection protection with 10 VDC up to 30 VDC
- With light reserve warning
- Optional: -40 °C up to +80 °C  
Protection to IP67 all around

[www.wachendorff-automation.com/wdg58b](http://www.wachendorff-automation.com/wdg58b)

**Available PPR** up to 25000 PPR

### Mechanical Data

#### Housing

- Clamping flange: Aluminium
- Cap: Aluminium, powder coated
- Cam mounting: pitch 69 mm

#### Shaft

- Material: stainless steel
- Permitted load on shaft end: max. 220 N radial  
max. 120 N axial
- Starting torque: approx. 1 Ncm at ambient temperature

#### Bearings

- Type: 2 precision ball bearings
- Service life: 1 x 10<sup>9</sup> revs. at 100 % rated shaft load  
1 x 10<sup>10</sup> revs. at 40 % rated shaft load  
1 x 10<sup>11</sup> revs. at 20 % rated shaft load

Max. operating speed: 8000 rpm

Weight: approx. 250 g

Connections: cable or connector

Protection rating: IP67, shaft sealed to IP65  
(EN 60529)

Operating temperature: -20 °C up to +80 °C, 1 Vss: -10 °C up to +70 °C  
Storage temperature: -30 °C up to +80 °C

### Machinery Directive: basic data safety integrity level

MTTF<sub>d</sub>: 200 a

Mission time (T<sub>M</sub>): 25 a

Nominal service life 1 x 10<sup>11</sup> revs. at 8000 rpm and 20 % rated

(L<sub>10h</sub>): shaft load

Diagnostic coverage (DC): 0 %

### Electrical Data

Power supply/ 4.75 VDC up to 5.5 VDC: max. 100 mA  
Open circuit current 5 VDC up to 30 VDC: max. 70 mA  
consumption: 10 VDC up to 30 VDC: max. 100 mA

Output circuit: TTL, RS422 compatible  
HTL  
1 Vss Sin/Cos

Pulse frequency: TTL ≤ 5000 PPR: max. 200 kHz  
HTL ≤ 5000 PPR: max. 200 kHz  
TTL > 5000 PPR: max. 2 MHz  
HTL > 5000 PPR: max. 600 kHz  
1 Vss Sin/Cos: max. 100 kHz

Channels: AB, ABN and inverted signals

Load: max. 40 mA/channel,  
@ 1 Vss Sin/Cos: 120 Ohm termination

Circuit protection: circuit type F24, G24, H24, I24, P24, R24 only

Accuracy: Phase offset: 90° ± max. 7.5 %  
of the pulse length  
pulse-/pause-ratio: 50 % ± max. 7 %

### Further technical information on:

[www.wachendorff-automation.com/gtd](http://www.wachendorff-automation.com/gtd)

Matching accessories on: [www.wachendorff-automation.com/acs](http://www.wachendorff-automation.com/acs)

### Cable connection K2, K3, L2, L3 with 2 m cable

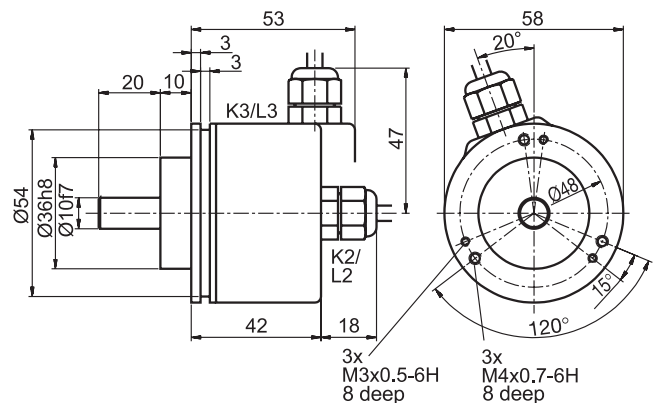

### Connector (M16x0.75) SI, SH, 5-, 6-, 8-, 12-pin and S2, S3, 7-pin

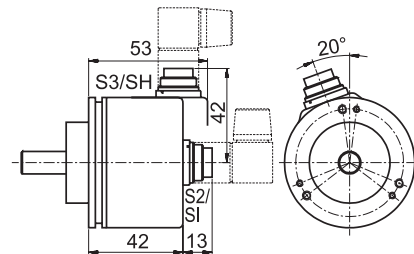

### Connector (M23) S4, S5, S4R, S5R, 12-pin

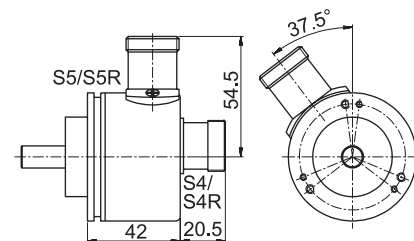

### MIL-connector S6, 6-pin

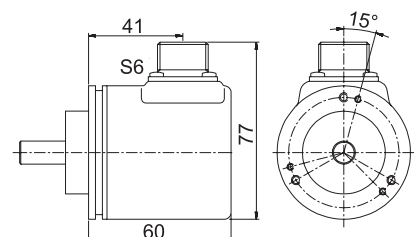

**Valve-connector S7, 4-pin**

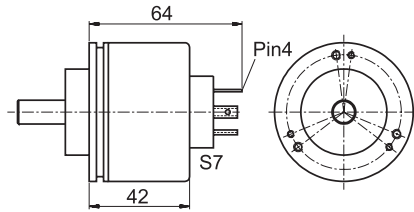

**Sensor-connector (M12x1) SB, SC, 4-, 5-, 8-, 12-pin**

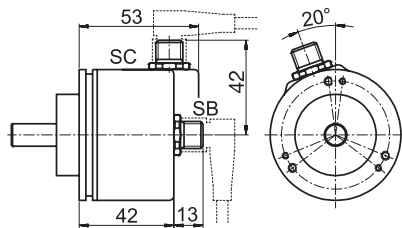

All dimensional specifications in mm.

**Options:**

**Low-temperature:**

The encoder WDG 58B with the output circuit types F24, G24, H24, I24, P24, R24, F05, G05, I05, P05, 245 and 645 is also available with the extended temperature range -40 °C up to +80 °C (measured at the flange). When ordering please add the suffix code - ACA.

**Shaft with flat:**

The encoder WDG 58B can be supplied with a shaft with flat. When ordering please add the suffix code - AAF.

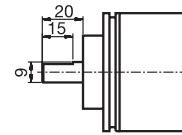

Drawing 58B-AAF

**Low-friction bearings:**

The encoder WDG 58B is also available as a particularly smooth-running low-friction encoder. The starting torque is thereby changed to ≤ 0.1 Ncm and the protection class at the shaft input to IP50. When ordering please add the suffix code - AAC.

**Shafts sealed to IP67 (not for 1 Vss Sin/Cos):**

The encoder WDG 58B can be supplied in a full IP67 version. When ordering please add the suffix code - AAO.

Max. RPM	Permitted Shaft-Loading axial	Max. PPR	Starting-torque
3500 rpm	100 N	110 N	2500 PPR
			approx. 4 Ncm

Amended specifications for shaft sealed to IP67.

**Cable length:**

The encoder WDG 58B can be supplied with more than 2 m cable. The maximum cable length depends on the supply voltage and the frequency; see "General Technical Data":

[www.wachendorff-automation.com/gtd](http://www.wachendorff-automation.com/gtd)

Please extend the standard order code with a three figure number, specifying the cable length in decimetres.

Example: 3 m cable = 030

**Ordering information:**

Please see our general technical data at: [www.wachendorff-automation.com/gtd](http://www.wachendorff-automation.com/gtd)

Output circuit:				
Resolution PPR	Power supply VDC	Output circuit	Light reserve warning	Order Key
up to 1024	5 - 30	HTL	-	H30
		HTL inverted	-	R30
up to 5000	4,75 - 5,5	TTL	•	G05
		TTL, RS422 comp., inverted	-	H05
		TTL, RS422 comp., inv.	-	R05
	10 - 30	HTL	•	G24
		HTL inverted	•	H24
		TTL, RS422 comp., inv.	•	I24
10000 up to 25000	4,75 - 5,5	TTL	-	F05
		TTL, RS422 comp., inv.	-	P05
	10 - 30	HTL	-	F24
		HTL inverted	-	P24
up to 2048	4,75 - 5,5	TTL, RS422 comp., inv.	-	645
		1 Vss Sin/Cos	-	SIN

**Channels:** AB, ABN (SIN: AB)

**Pulses per revolution PPR:**  
 2, 10, 15, 20, 24, 25, 30, 36, 40, 48, 50, 60, 64, 72, 87, 90, 100, 120, 125, 127, 128, 150, 160, 180, 200, 216, 240, 250, 254, 256, 300, 314, 320, 360, 400, 500, 512, 571, 600, 625, 720, 750, 768, 800, 810, 900, 1000, 1024, 1200, 1250, 1270, 1440, 1500, 1800, 2000, 2048, 2400, 2500, 3000, 3600, 4000, 4096, 4685, 5000, 10000, 12500, 20000, 25000.  
 1 Vss Sin/Cos 1024 PPR and 2048 PPR only  
 Other PPRs on request

Electrical connections:			
Order key	Outgoing	Description	ABN inv.
<b>Cable:</b> (Length 2 m standard)			
K2	axial	shield not connected	•
L2		shield connected to encoder housing	•
K3	radial	shield not connected	•
L3		shield connected to encoder housing	•
<b>Connector:</b>			
SI5	axial	5-pin, connector	-
SH5	radial		-
SI6	axial	6-pin, connector	-
SH6	radial		-
SI8	axial	8-pin, connector	•
SH8	radial		•
SI12	axial	12-pin, connector	•
SH12	radial		•
S2	axial	7-pin, connector	-
S3	radial		-
S4/S4R	axial	12-pin, connector	•
S5/S5R	radial	(R = clockwise pin count)	•
S6	axial	6-pin, MIL-connector	-
S7	radial	4-pin, Valve-connector	-
SB4	axial	4-pin, M12-sensor-connector	-
SC4	radial		-
SB5	axial	5-pin, M12-sensor-connector	-
SC5	radial		-
SB8	axial	8-pin, M12-sensor-connector	•
SC8	radial		•
SB12	axial	12-pin, M12-sensor-connector	•
SC12	radial		•

**Options:**  
 Empty = Without option  
 ACA = Low-temperature -40 °C up to +80 °C  
 AAF = Shaft with flat  
 AAC = Low-friction bearings  
 AAO = Shaft sealed to IP67  
 In decimetres = Cable length

**Order No.:**

Example	WDG 58B	5000	ABN	G24	K2	
Your encoder	WDG 58B					