

## Description

Single or multipole hydraulic-magnetic circuit breakers with trip-free-mechanism and toggle actuation. A choice of switching characteristics ensures suitability for a wide range of applications. Industry standard dimensions and panel mounting. Auxiliary contacts optional. Low temperature sensitivity at rated load. Approved to CBE standard EN 60934 (IEC 60934)S-type HM CBE.

## Typical applications

In the business fields Communication and Transport: power supplies, switchgear, instrumentation and process control engineering.

## Standard current ratings and typical internal resistance values

Current rating (A)	Trip curves and internal resistance (Ω) per pole			
	F1	F2	K1, M1, T1,	K2, M2, T2
0.05	276	152	452	376
0.1	58	37	100	94
1	0.58	0.35	0.95	0.90
2	0.145	0.096	0.26	0.20
3	0.065	0.048	0.10	0.10
5	0.025	< 0.02	0.042	0.040
10	< 0.02	< 0.02	< 0.02	< 0.02
15	< 0.02	< 0.02	< 0.02	< 0.02
20	< 0.02	< 0.02	< 0.02	< 0.02
25	< 0.02	< 0.02	< 0.02	< 0.02
30	< 0.02	< 0.02	< 0.02	< 0.02
40	< 0.01	< 0.01	< 0.01	< 0.01
50	< 0.01	< 0.01	< 0.01	< 0.01
60	< 0.01	< 0.01	< 0.01	< 0.01
80	< 0.01	< 0.01	< 0.01	< 0.01
100	< 0.01	< 0.01	< 0.01	< 0.01
125	< 0.01	< 0.01	< 0.01	< 0.01

## Interrupting capacity to EN 60934, UL 489 and UL 1077

### IEC 60934 – test series E

voltage	number of poles	$I_N$ max. (A)	$I_{cn}$
DC 80 V	1	0.05...125	10,000
DC 80 V	2	0.05...125	10,000
AC 240 V	1	0.05...125	5,000
AC 240/415 V	3 (4)	0.05...125	5,000

### UL 489 – test sequence Z

voltage	number of poles	$I_N$ max. (A)	$I_{cn}$
DC 80 V	1	0.05...125	10,000
DC 80 V	2	0.05...125	10,000
AC 120 V	1	0.05...80	5,000
AC 240 V	1	0.05...20	5,000
AC 120/240 V	1 (2)	0.05...80	5,000

### UL 1077

voltage	number of poles	$I_N$ max. (A)	$I_{cn}$
DC 80 V	1-6	0.05...125	10,000
AC 277/480 V	1-6	0.05...125	5,000

**NEW**



1 pole



2 pole

**8345**

## Technical data

Voltage rating	3 AC 415 V; AC 277/480 V; AC 120/240 V; AC 240 V; DC 80 V,
Current rating range	0.05...125 A single and multipole 150...180 A single pole, two poles connected in parallel higher ratings upon request
Auxiliary circuit	AC 240 V/DC 28 V 6 A DC 65 V 1 A; DC 80 V 0.5 A
Typical life	10,000 operations at $1 \times I_N$
Ambient temperature	-40 °C...+85 °C (-40 °...+185 °F)
Insulation co-ordination (IEC 60664)	2.5 kV/2 reinforced insulation in operating area
Dielectric strength	test voltage
operating area	AC 3000 V
pole to pole	AC 1500 V
main to auxiliary circuit	AC 1500 V
switching to trip circuit	AC 1500 V
Insulation resistance	> 100 MΩ (DC 500 V)
Degree of protection (IEC 60529)	operating area IP40 terminal area IP00
Vibration	with toggle down: 10 g (57-2000 Hz) ±0,76mm (10-57Hz) at $0.9 I_N$ directions 1,2,3,4,5: 10 g at $1 \times I_N$ with curves F1, F2: 10 g at $0.8 \times I_N$ in all planes. (57-2000 Hz) ±0.76 mm (10-57 Hz) to IEC 60068-2-6, test Fc 10 frequency cycles/axis
Shock	directions 1,2,3,4,5: 100 g (11 ms) at $1 \times I_N$ , direction 6: 100 g (11 ms) at $0.8 \times I_N$ , with curves F1, F2: 100 g (11 ms) at $0.8 \times I_N$ to IEC 60068-2-27, test Ea
Corrosion	96 hours at 5% salt mist, to IEC 60068-2-11, test Ka
Humidity	240 hours at 95 % RH, to IEC 60068-2-3, test Ca
Mass	approx. 90 - 120 g per pole depending on version

## Approvals

VDE (EN 60934)

UL 489

UL 1077

## Ordering information

Type No.									
8345									
<b>Mounting</b>									
B flange mounting, with rectangular aperture with mounting nut 6-32 UNC									
C flange mounting, with rectangular aperture with mounting nut M3									
E flange mounting, with round aperture with mounting nut 6-32 UNC									
F flange mounting, with round aperture with mounting nut M3									
<b>Configuration</b>									
0 without barrier									
1 with small barrier									
2 with large barrier (required for UL 489 multipole)									
<b>Number of poles</b>									
0 single pole unprotected									
1 single pole protected									
2 two pole protected									
3 three pole protected									
4 four pole protected									
P single pole protected, two poles connected in parallel									
<b>Actuator configuration</b>									
A all poles with standard toggle									
B reduced number of standard toggles									
Z without actuator									
<b>Terminal design</b>									
K screw terminals $M4 \leq 35$ A									
L screw terminals $M5 \leq 50$ A									
M solder terminals $\leq 75$ A									
P blade terminals $\leq 35$ A									
R round connectors 6 mm									
S stud terminals $M5 \leq 60$ A									
T stud terminals 10-32 UNF-3A $\leq 60$ A									
U stud terminals M6									
V stud terminals 1/4-20UNC-3A $\leq 125$ A									
<b>Terminal hardware</b>									
0 without									
3 with washer and nut									
6 Phillips screws									
<b>Characteristic curve</b>									
F1 instantaneous trip DC $1.01-1.5 \times I_N$									
F2 instantaneous trip AC $1.01-1.5 \times I_N$									
K1 short delay DC									
K2 short delay AC									
M0 medium delay AC/DC									
M1 medium delay DC									
M2 medium delay AC									
Q0 switch only									
T1 long delay DC									
T2 long delay AC									
<b>Illumination</b>									
- without									
<b>Version</b>									
D standard									
<b>Colour configuration</b>									
B1 black front plate, black actuator, (black actuator base)									
B2 black front plate, black actuator, (white actuator base)									
<b>Marking</b>									
front plate                      actuator base									
A1 without                      without									
A2 $I_N$ without									
A3 $I_N$ without									
characteristic curve									
A4 $I_N$ without									
characteristic curve,              wiring diagram on side									
B1 without                      ON-OFF									
B2 $I_N$ ON-OFF									
B3 $I_N$ ON-OFF									
characteristic curve									
B4 $I_N$ ON-OFF									
characteristic curve,              wiring diagram on side									
<b>Rated voltage</b>									
B AC or $\leq 80$ V DC									
8345 - C 0 1 A - U 3 M1 - . D B1 A1 B - 60 A - ...									

8345 - C 0 1 A - U 3 M1 - . D B1 A1 B - ...									
<b>Current ratings</b>									
0.1...125 A									
150 - 180 A single pole protected,									
two poles connected in parallel									
<b>Approvals (optional)</b>									
V UL 489									
8345 - C 0 1 A - U 3 M1 - . D B1 A1 B - 60 A - . ordering example									

Remote trip coil available to special order!

## Ordering information for auxiliary contact module

Type number									
X8345									
<b>Module</b>									
S auxiliary contact module									
<b>Auxiliary contacts</b>									
01 in all poles									
02 in pole 1 only									
03 in poles 1 + 3 only									
04 in pole 2 only									
<b>Auxiliary contact version</b>									
H auxiliary contacts standard									
(asymmetrical terminals not for UL 489)									
K auxiliary contacts (symmetrical terminals)									
<b>Auxiliary contact function</b>									
W1 1 changeover									
<b>Terminal design</b>									
02 microswitch with blade terminals									
DIN 46244-A2,8-0,5									
M mounted to base unit									
X8345 - S 01 H W1 02 M ordering example									

## Dimensions

### Mounting version B/C

Flange mounting rectangular aperture

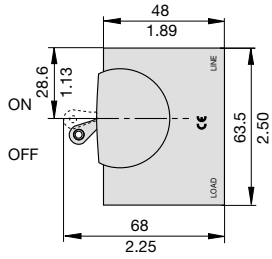

number of poles 1 to 4  
pole 1 2 3 4  
mounting thread M3 or 6-32  
mounting depth 4.2 mm/.165 in.

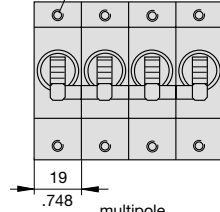

### Cut-out dimensions:

1 pole

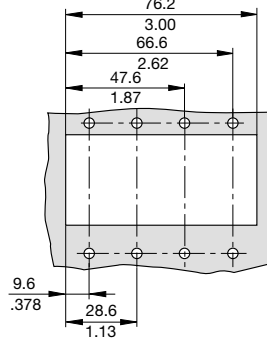
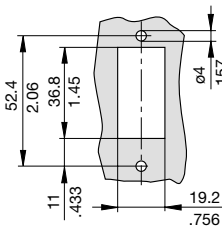

### Mounting version E/F

Flange mounting round aperture

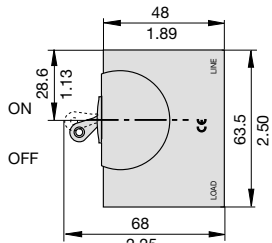

number of poles 1 to 4  
pole 1 2 3 4  
mounting thread M3 or 6-32  
mounting depth 4.2 mm/.165 in.

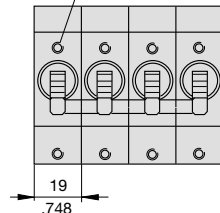

### Cut-out dimensions:

1 pole

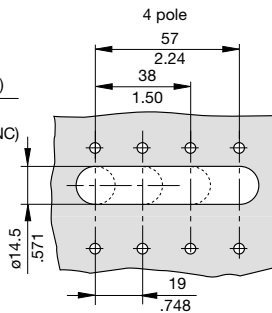
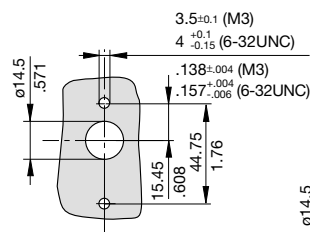

## Installation drawing

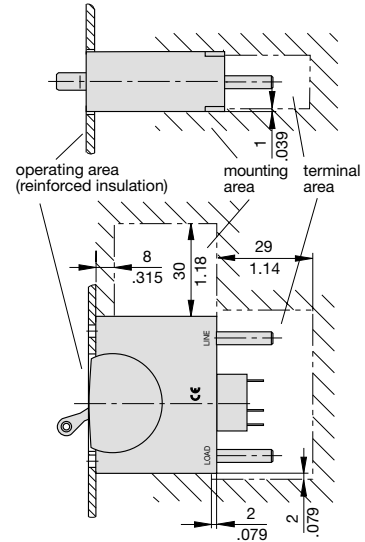

3

## Actuator configuration

### A 1 toggle per pole

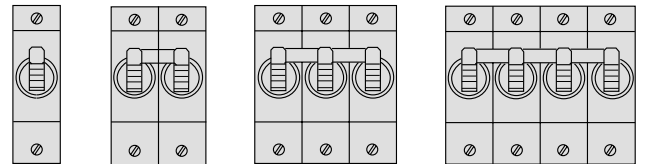

### B reduced number of toggles per unit

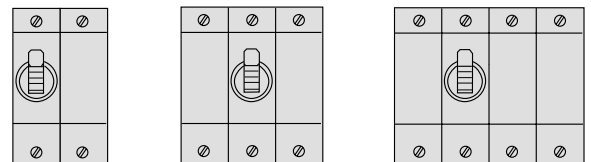

### Z without toggles

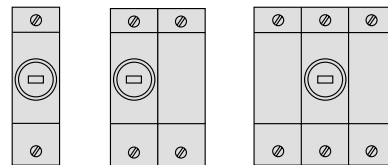

This is a metric design and millimeter dimensions take precedence (mm/inch)

## Terminal design / Dimensions

### P - with blade terminals

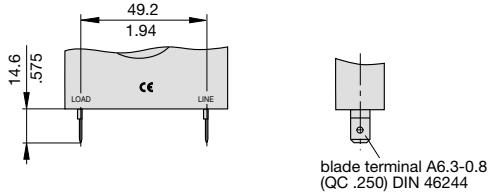

blade terminal A6.3-0.8  
(QC .250) DIN 46244

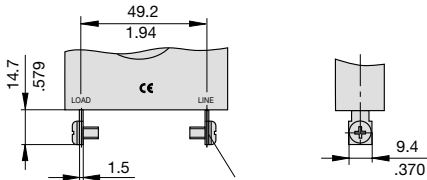

terminal with flat head screw M4 or M5  
tightening torque max. 1.2 Nm

### M - with solder terminals

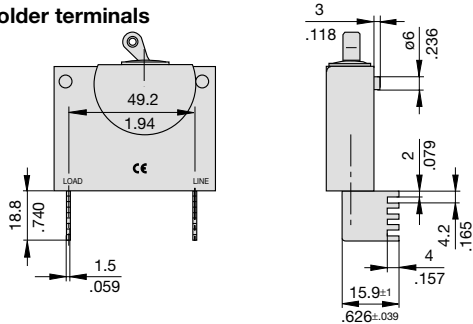

### S/U/T/V with auxiliary contacts (version H) asymmetrical terminals (not for UL 489)

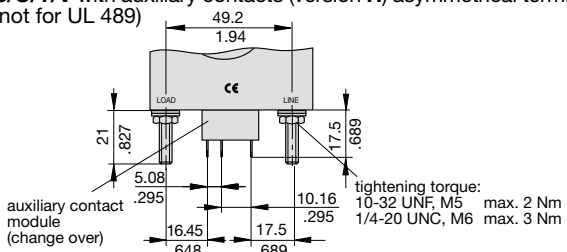

tightening torque:  
10-32 UNF, M5 max. 2 Nm  
1/4-20 UNC, M6 max. 3 Nm

### R round connectors D= 6 mm (dia .236) (version H) asymmetrical terminals (not for UL 489)

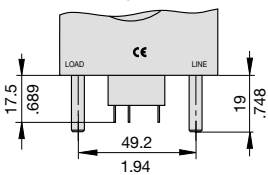

### S/U/T/V with auxiliary contacts (version K) symmetrical terminals

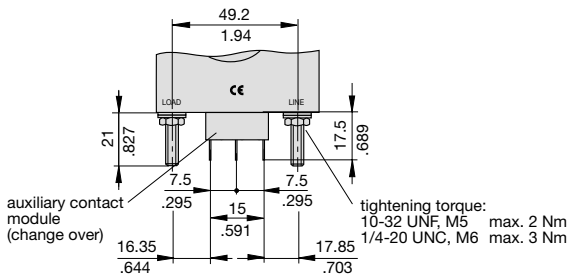

tightening torque:  
10-32 UNF, M5 max. 2 Nm  
1/4-20 UNC, M6 max. 3 Nm

### R round connectors D= 6 mm (dia .236) (version K) symmetrical terminals

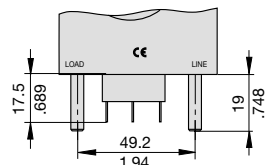

## Number of poles / Dimensions

### P 1 pole protected, 2 poles connected in parallel for rating currents from 150 to 180 A

tightening torque:  
M8 max. 6 Nm

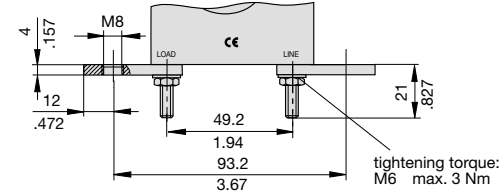

tightening torque:  
M6 max. 3 Nm

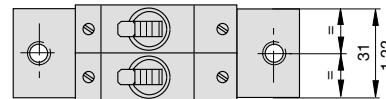

## Interphase barriers / Dimensions

### 1 - Interphase barrier (small)

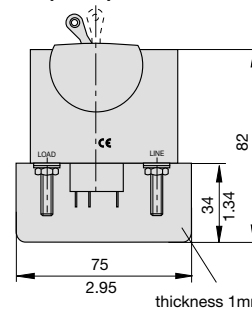

### 2 - Interphase barrier (large)

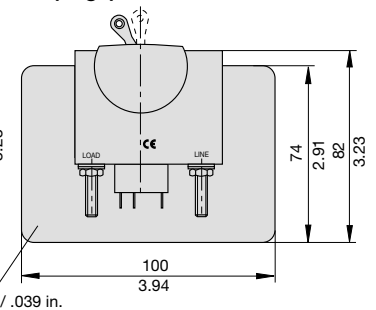

thickness 1mm / .039 in.

## Internal connection diagram

### 1 pole protected magnetically

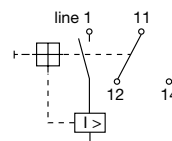

### multi pole

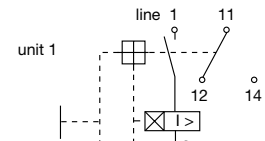

### 1 pole protected hydraulic-magnetically

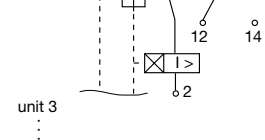
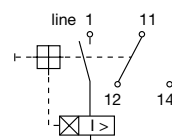

This is a metric design and millimeter dimensions take precedence (mm / inch)

## Typical time/current characteristics at +23 °C / +73.4 °F

(trip time at rated current and all poles symmetrically loaded)

**Curve F1 (instantaneous) for DC**

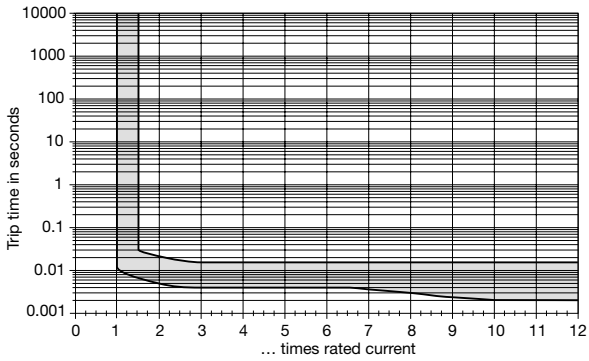

**Curve M0 (medium delay) for AC/DC**

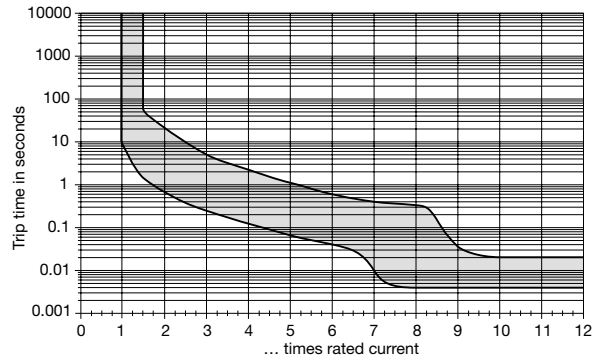

**Curve F2 (instantaneous) for AC 50/60 Hz**

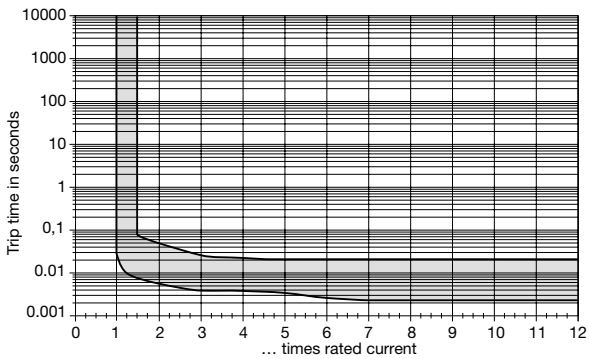

**Curve M1 (medium delay) for DC**

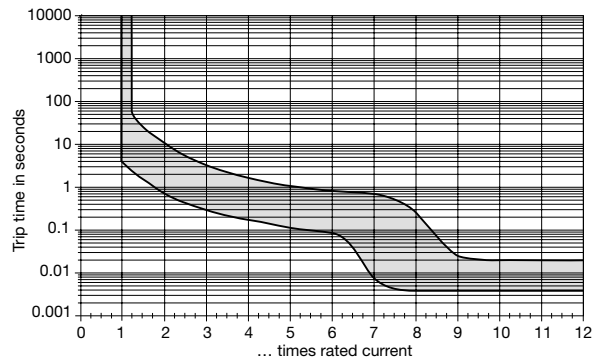

**Curve K1 (short delay) for DC**

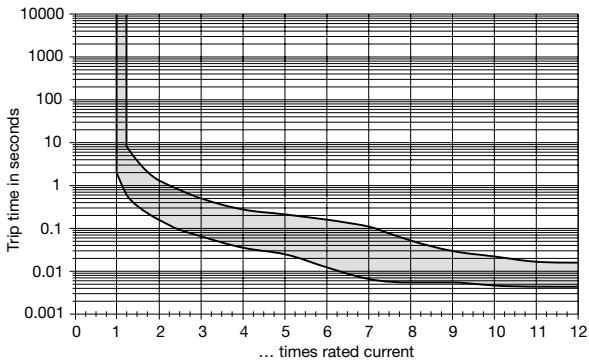

**Curve M2 (medium delay) for AC 50/60 Hz**

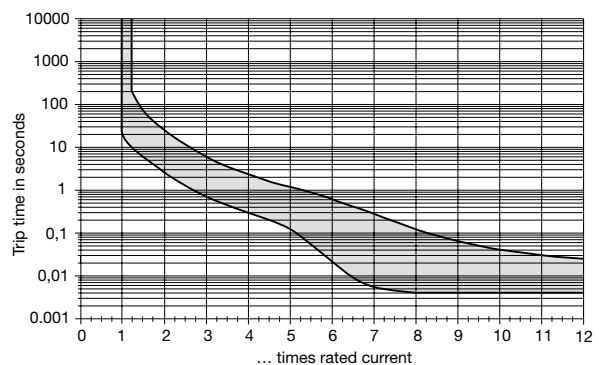

**Curve K2 (short delay) for AC 50/60 Hz**

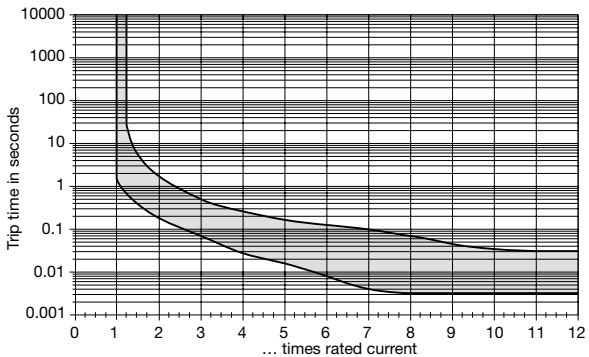

All curves will only be maintained if the escutcheon is mounted on a vertical surface.

**Other characteristic curves to special order ( e. g. pulse delayed, for high inrush currents or capacitive loads).**

## Typical time/current characteristics at +23 °C / +73.4 °F

(trip time at rated current and all poles symmetrically loaded)

### Curve T1 (long delay) for DC

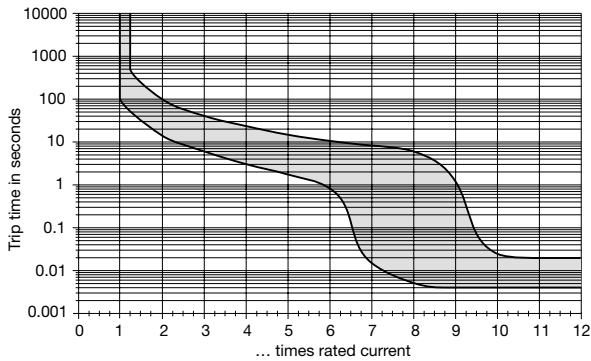

### Curve T2 (long delay) for AC 50/60 Hz

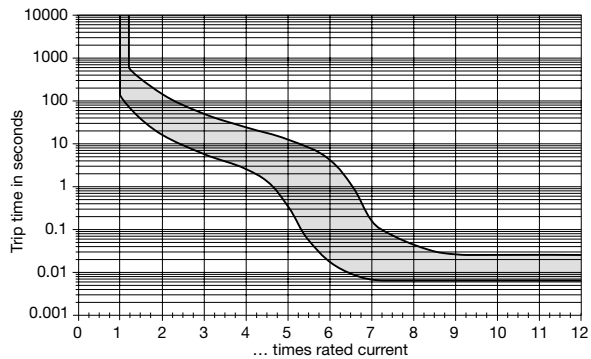

All curves will only be maintained if the escutcheon is mounted on a vertical surface.

**Other characteristic curves to special order ( e. g. pulse delayed, for high inrush currents or capacitive loads).**

3

## Accessories

- Splash cover** (IP64) for 1, 2, 3 pole (only for mounting version B/C)
- Y 306 265 01** 1 pole
- Y 306 266 01** 2 pole
- Y 306 267 01** 3 pole

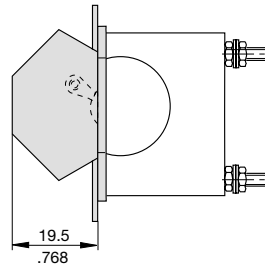

- Toggle guard** (only for mounting version B/C)
- Y 307 381 01**

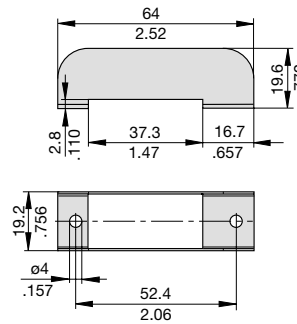

## Shock directions

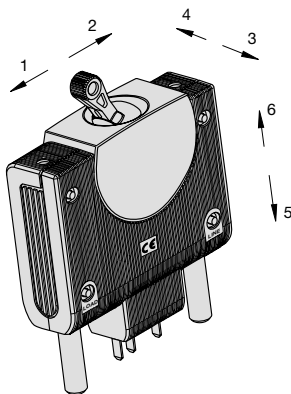

This is a metric design and millimeter dimensions take precedence ( $\frac{\text{mm}}{\text{inch}}$ )

All dimensions without tolerances are for reference only. In the interest of improved design, performance and cost effectiveness the right to make changes in these specifications without notice is reserved. Product markings may not be exactly as the ordering codes. Errors and omissions excepted.