

BLUE LINE™
Hyper 5 mm (T1 3/4) LED, Non Diffused
Hyper-Bright LED

LB 5436

Besondere Merkmale

- nicht eingefärbtes, klares Gehäuse
- zur Einkopplung in Lichtleiter
- als optischer Indikator einsetzbar
- Lötspieße ohne Aufsetzebene
- gegurtet lieferbar
- ESD-sicher bis 2 kV nach MIL STD 883D, Method 3015.7

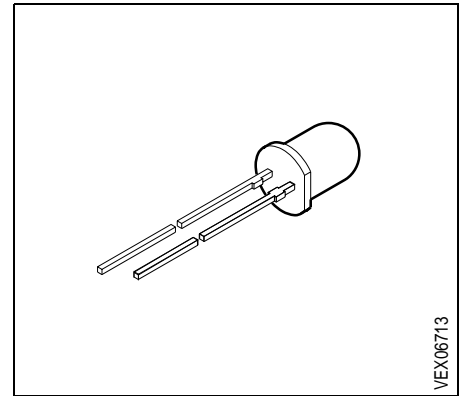

Features

- colorless, clear package
- optical coupling into light pipes
- for use as optical indicator
- solder leads without stand-off
- available taped on reel
- ESD withstand voltage of 2 kV according to MIL STD 883D, Method 3015.7

Typ	Emissionsfarbe	Gehäusefarbe	Lichtstärke	Bestellnummer
Type	Color of Emission	Color of Package	Luminous Intensity $I_F = 10 \text{ mA}$ $I_V \text{ (mcd)}$	Ordering Code
LB 5436	blue	colorless clear		Q62703-Q4028
LB 5436-N			25 ... 50	
LB 5436-P			40 ... 80	
LB 5436-Q			63 ... 125	

Streuung der Lichtstärke in einer Verpackungseinheit $I_{V \text{ max}} / I_{V \text{ min}} \leq 2.0$.
 Luminous intensity ratio in one packaging unit $I_{V \text{ max}} / I_{V \text{ min}} \leq 2.0$.

Helligkeitswerte werden bei einer Strompulsdauer von 25 ms spezifiziert.
 Luminous intensity is specified at a current pulse duration of 25 ms.

**Grenzwerte
Maximum Ratings**

Bezeichnung Parameter	Symbol Symbol	Werte Values	Einheit Unit
Betriebstemperatur Operating temperature range	T_{op}	- 40 ... + 100	°C
Lagertemperatur Storage temperature range	T_{stg}	- 40 ... + 100	°C
Sperrschichttemperatur Junction temperature	T_j	+ 100	°C
Durchlaßstrom Forward current	I_F	20	mA
Sperrspannung ¹⁾ Reverse voltage ¹⁾	V_R	5	V
Verlustleistung Power dissipation $T_A \leq 25 \text{ °C}$	P_{tot}	100	mW
Wärmewiderstand Thermal resistance Sperrschicht / Umgebung Junction / air Montage auf PC-board*) (Padgröße $\geq 16 \text{ mm}^2$) mounted on PC board*) (pad size $\geq 16 \text{ mm}^2$)	$R_{th JA}$	500	K/W

¹⁾ Belastung in Sperrichtung sollte vermieden werden.

¹⁾ Reverse biasing should be avoided.

*) PC-board: FR4

Kennwerte ($T_A = 25\text{ °C}$)
Characteristics

Bezeichnung Parameter	Symbol Symbol	Werte Values		Einheit Unit
		typ.	max.	
Wellenlänge des emittierten Lichtes Wavelength at peak emission $I_F = 10\text{ mA}$	λ_{peak}	428	–	nm
Dominantwellenlänge Dominant wavelength $I_F = 10\text{ mA}$	λ_{dom}	466	–	nm
Spektrale Bandbreite bei 50% $I_{\text{rel max}}$ Spectral bandwidth at 50% $I_{\text{rel max}}$ $I_F = 10\text{ mA}$	$\Delta\lambda$	60	–	nm
Abstrahlwinkel bei 50% I_v (Vollwinkel) Viewing angle at 50% I_v	2ϕ	70	–	Grad deg.
Durchlaßspannung Forward voltage $I_F = 10\text{ mA}$	V_F	3.5	4.2	V
Sperrstrom Reverse current $V_R = 5\text{ V}$	I_R	0.01	10	μA
Temperaturkoeffizient von λ_{dom} ($I_F = 10\text{ mA}$) Temperature coefficient of λ_{dom} ($I_F = 10\text{ mA}$)	TC_λ	0.03	–	nm/K
Temperaturkoeffizient von λ_{peak} ($I_F = 10\text{ mA}$) Temperature coefficient of λ_{peak} ($I_F = 10\text{ mA}$)	TC_λ	0.004	–	nm/K
Temperaturkoeffizient von V_F ($I_F = 10\text{ mA}$) Temperature coefficient of V_F ($I_F = 10\text{ mA}$)	TC_V	– 3.1	–	mV/K

Relative spektrale Emission $I_{rel} = f(\lambda)$, $T_A = 25\text{ °C}$, $I_F = 10\text{ mA}$

Relative spectral emission

$V(\lambda)$ = spektrale Augenempfindlichkeit

Standard eye response curve

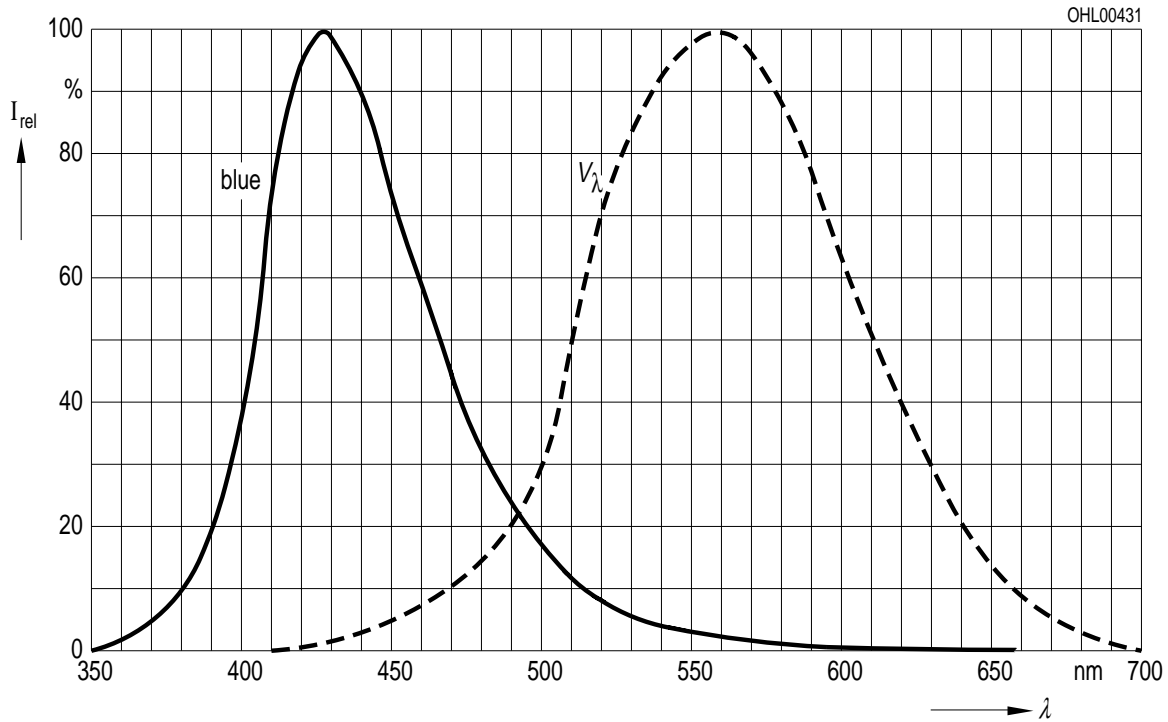

Abstrahlcharakteristik $I_{rel} = f(\varphi)$

Radiation characteristic

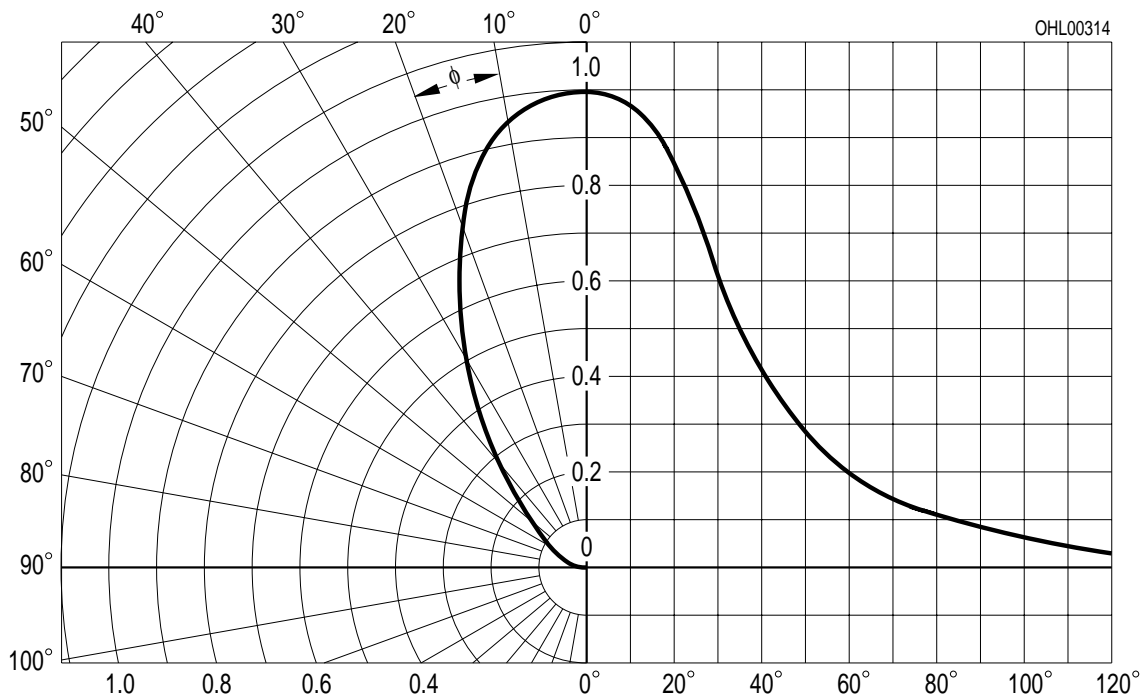

Durchlaßstrom $I_F = f(V_F)$

Forward current

$T_A = 25\text{ °C}$

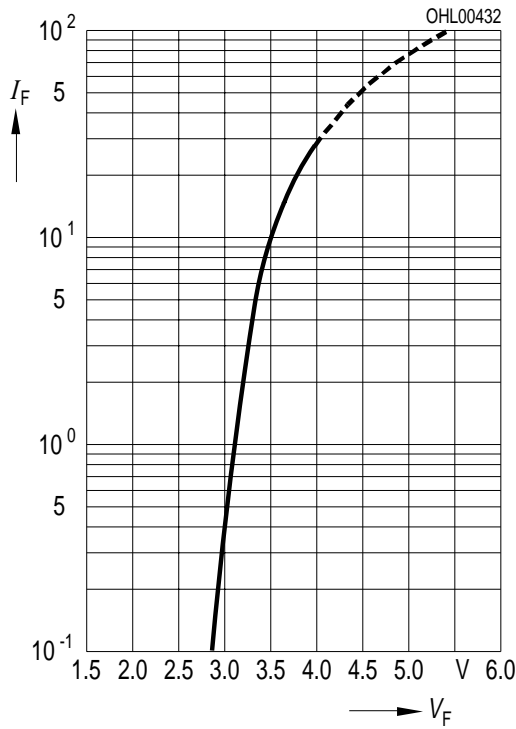

Relative Lichtstärke $I_V / I_{V(10\text{ mA})} = f(I_F)$

Relative luminous intensity

$T_A = 25\text{ °C}$

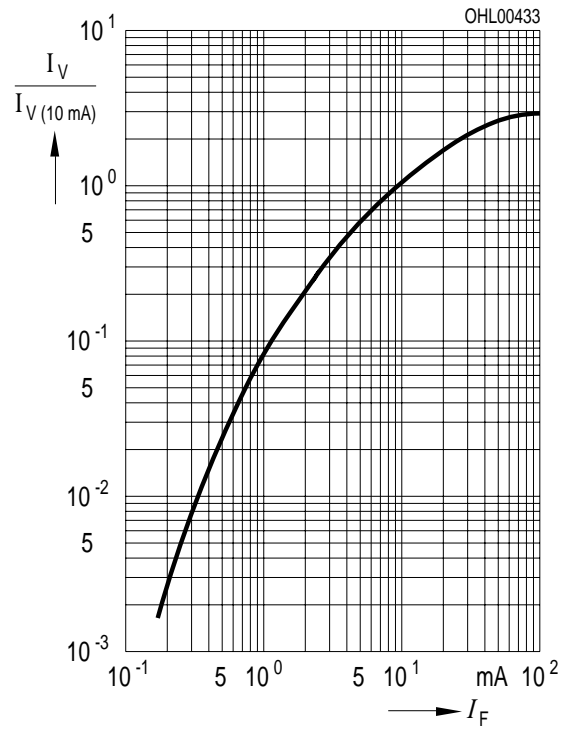

Maximal zulässiger Durchlaßstrom

Max. permissible forward current

$I_F = f(T_A)$

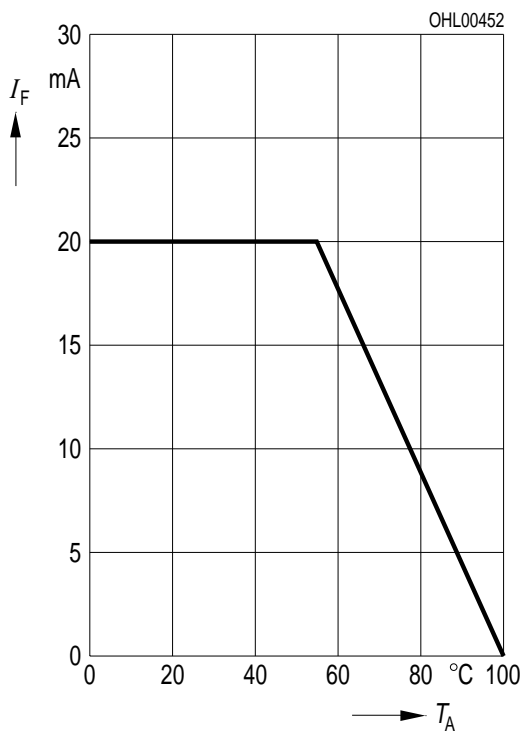

Relative Lichtstärke $I_V / I_{V(25\text{ °C})} = f(T_A)$

Relative luminous intensity

$I_F = 10\text{ mA}$

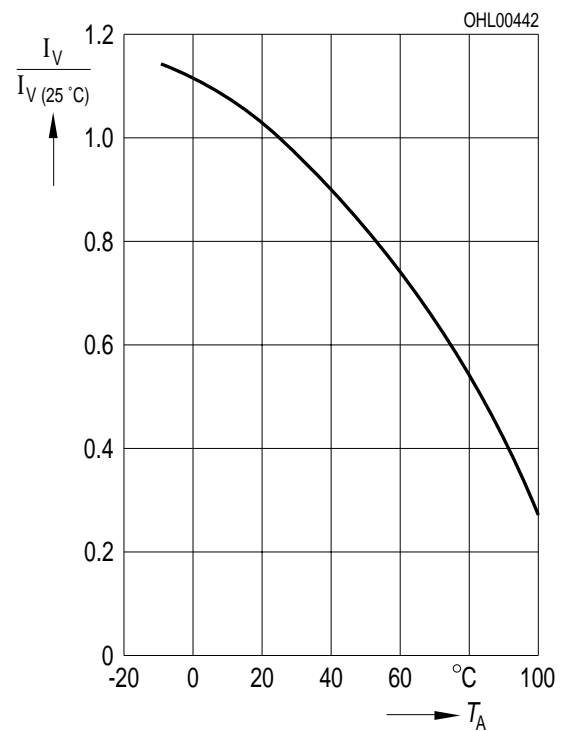

Maßzeichnung (Maße in mm, wenn nicht anders angegeben)
Package Outlines (Dimensions in mm, unless otherwise specified)

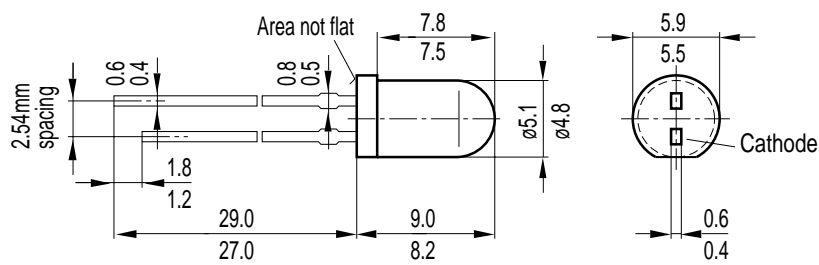

Approx. weight 0.35 g

GEX06713

Kathodenkennung: Kürzerer Lötspieß
Cathode mark: Short solder lead