

## Delay-on energisation PZA



### Unit features

- ▶ Positive-guided relay outputs:
  - 1 safety contact (N/O), delay-on energisation
  - 2 auxiliary contacts (N/C), delay-on energisation
- ▶ LED indicator for:
  - Switch status channel 1/2
  - Supply voltage
- ▶ 12 time values, set via rotary switch

### Safety features

- The relay meets the following safety requirements:
- ▶ The circuit is redundant with built-in self-monitoring.
  - ▶ The safety function remains effective in the case of a component failure.
  - ▶ The correct opening and closing of the safety function relays is tested automatically in each on-off cycle.

### Unit description

The unit operates as a time delay device

- ▶ in accordance with prEN 1088 (release with delay through timer)
- ▶ in safety circuits in accordance with VDE 0113-1 and EN 60204-1 (e.g. on movable guards)

The unit is designed for use with

- ▶ Safety relays from the PNOZ series
- ▶ Safety gate monitors from the PST series

The category that can be achieved in accordance with EN 954-1 depends on the category of the base unit. The PZA may not exceed this.

Delay-on energisation timer for unlocking an interlock with delay

### Approvals

	PZA
	◆
	◆
	◆

### Block diagram

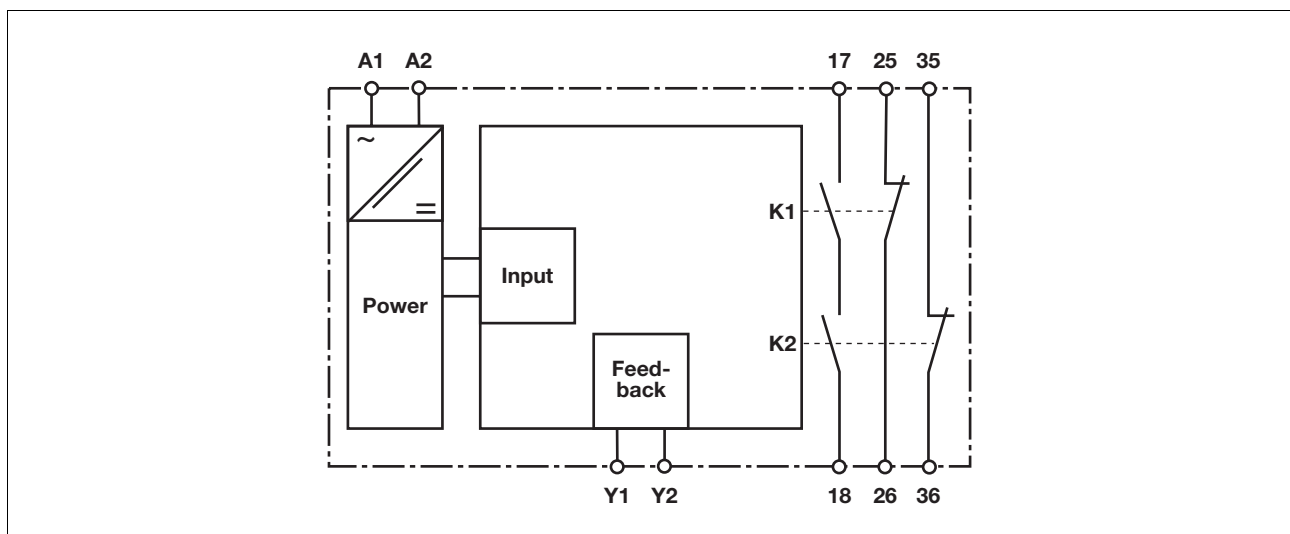

## Delay-on energisation PZA

### Function description

The timer is ready to start once the feedback loop is closed. If the supply

voltage at the input circuit is interrupted, the safety contact will open and the auxiliary contacts will close. If the input circuit is closed, i.e. supply volt-

age is present, the safety contact will be closed with delay-on energisation and the auxiliary contacts will be opened.

### Timing diagram

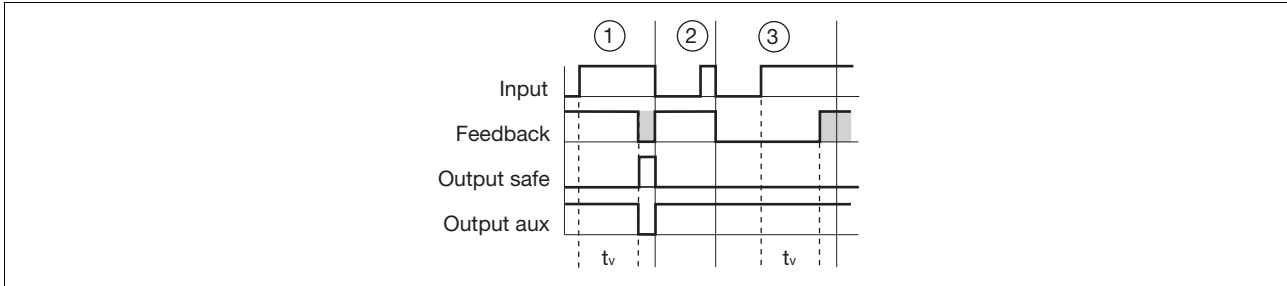

### Key

- ▶ Input: Input circuit A1-A2
- ▶ Feedback: Feedback loop Y1-Y2
- ▶ Output safe: Safety contact 17-18

- ▶ Output aux: Auxiliary contacts 25-26, 35-36
- ▶  $t_v$ : Delay time
- ①: Normal operating cycle

- ②: Fault: Input circuit opened too early
- ③: Fault: Feedback loop closed too late after  $t_v$  elapsed

### Wiring

Please note:

- ▶ Information given in the “Technical details” must be followed.
- ▶ Output is a safety contact, outputs are auxiliary contacts (e.g. for display)
- ▶ To prevent contact welding, a fuse should be connected before the output contacts (see technical details).
- ▶ Calculation of the max. cabling runs  $I_{max}$  in the input circuit:

$$I_{max} = \frac{R_{lmax}}{R_l / km}$$

$R_{lmax}$  = max. overall cable resistance (see technical details)

$R_l / km$  = cable resistance/km

- ▶ Use copper wire that can withstand 60/75 °C.
- ▶ Supply voltage 24 VDC: Shorts between the input circuit and feedback loop or earth faults in the feedback loop can damage the unit.
- ▶ We recommend the use of a short circuit-proof voltage supply with current limitation

## Delay-on energisation PZA

### Preparing for Operation

► Supply voltage

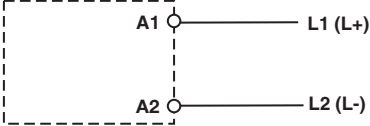
AC	
Input circuit is driven by connecting $U_B$	

► Feedback loop

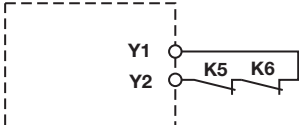
Feedback loop	
Contacts from external contactors	

## Delay-on energisation PZA

### Terminal configuration

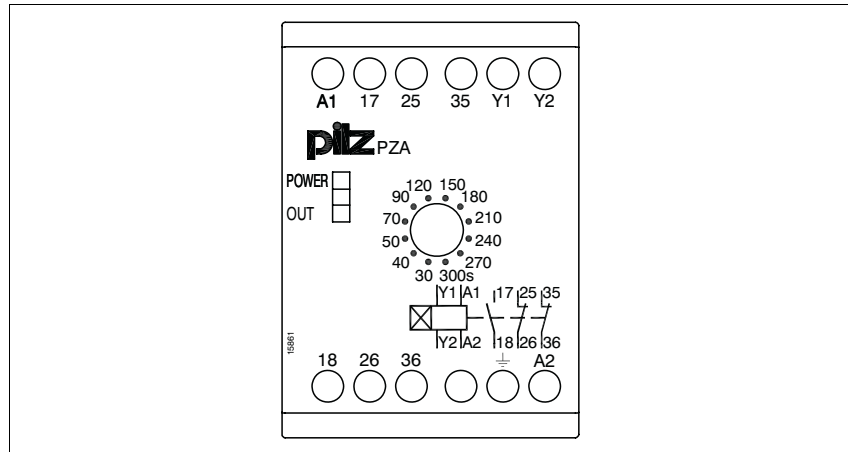

### Installation

- ▶ The safety relay should be installed in a control cabinet with a protection type of at least IP54.
- ▶ Use the notch on the rear of the unit to attach it to a DIN rail.
- ▶ Ensure the unit is mounted securely on a vertical DIN rail (35 mm) by using a fixing element (e.g. retaining bracket or an end angle).

### Dimensions

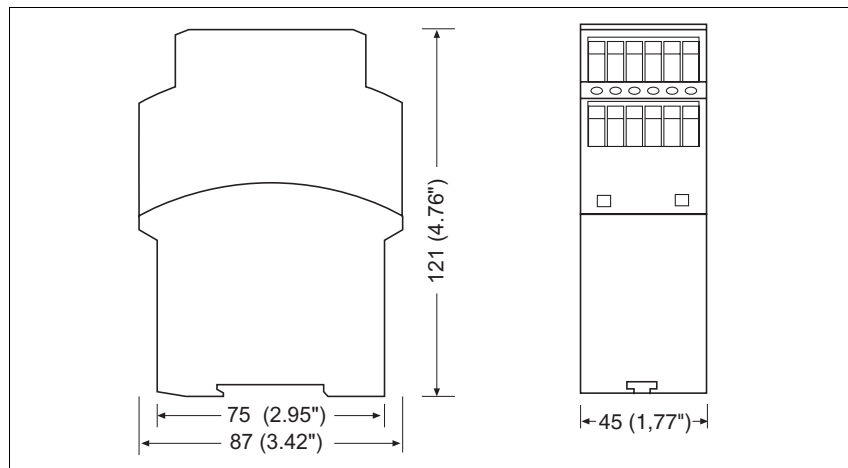

## Delay-on energisation PZA

### Notice

This data sheet is only intended for use during configuration. For installation and operation, please refer to the operating instructions supplied with the unit.

### Service life graph

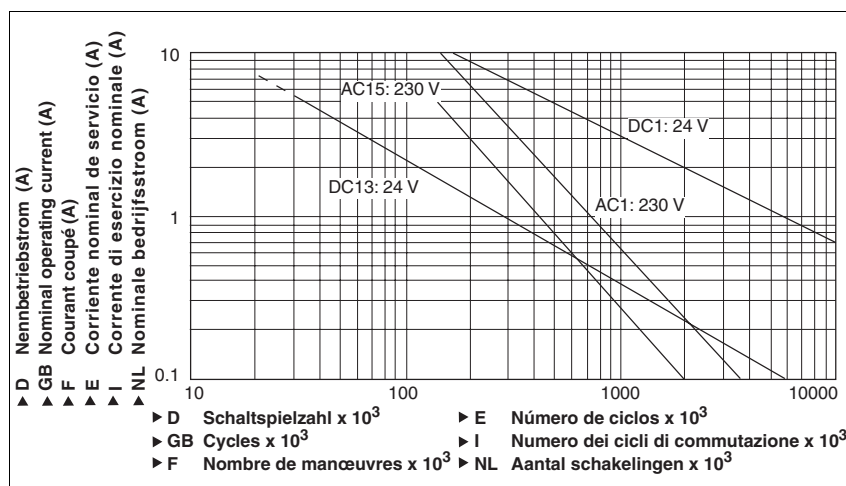

Technical details	
<b>Electrical data</b>	
Supply voltage	
Supply voltage U <sub>B</sub> AC	<b>24 V, 42 V, 110 - 120 V, 230 V</b>
Supply voltage U <sub>B</sub> DC	<b>24 V</b>
Voltage tolerance	<b>-15 %/+10 %</b>
Power consumption at U <sub>B</sub> AC	<b>4.5 VA</b> Order no.: 774020, 774021, 774023, 774026, 774031, 774035, 774038, 774040
Power consumption at U <sub>B</sub> DC	<b>3.0 W</b> Order no.: 774028, 774029, 774030, 774041
Frequency range AC	<b>50 - 60 Hz</b>
Residual ripple DC	<b>10 %</b>
Voltage and current at	
Feedback loop DC: <b>24.0 V</b>	<b>50.0 mA</b>
Number of output contacts	
Safety contacts (N/O), delayed:	<b>1</b>
Auxiliary contacts (N/C), delayed:	<b>2</b>
Category of safety contacts in accordance with EN 954-1	
Delay time <30 s	<b>3</b> Order no.: 774020, 774021, 774023, 774026, 774029, 774030, 774031, 774035, 774038, 774040, 774041
Delay time ≥30 s	<b>1</b> Order no.: 774020, 774021, 774023, 774026, 774028, 774029, 774030, 774031, 774035, 774040
Utilisation category in accordance with <b>EN 60947-4-1</b>	
Safety contacts: AC1 at <b>240 V</b>	<b>I<sub>min</sub>: 0.01 A, I<sub>max</sub>: 6.0 A</b> <b>P<sub>max</sub>: 1500 VA</b>
Safety contacts: DC1 at <b>24 V</b>	<b>I<sub>min</sub>: 0.01 A, I<sub>max</sub>: 6.0 A</b> <b>P<sub>max</sub>: 150 W</b>
Auxiliary contacts: AC1 at <b>240 V</b>	<b>I<sub>min</sub>: 0.01 A, I<sub>max</sub>: 6.0 A</b> <b>P<sub>max</sub>: 1500 VA</b>
Auxiliary contacts: DC1 at <b>24 V</b>	<b>I<sub>min</sub>: 0.01 A, I<sub>max</sub>: 6.0 A</b> <b>P<sub>max</sub>: 150 W</b>
Utilisation category in accordance with <b>EN 60947-5-1</b>	
Safety contacts: AC15 at <b>230 V</b>	<b>I<sub>max</sub>: 4.0 A</b>
Safety contacts: DC13 at <b>24 V</b> (6 cycles/min)	<b>I<sub>max</sub>: 3.0 A</b>
Auxiliary contacts: AC15 at <b>230 V</b>	<b>I<sub>max</sub>: 4.0 A</b>
Auxiliary contacts: DC13 at <b>24 V</b> (6 cycles/min)	<b>I<sub>max</sub>: 3.0 A</b>
Contact material	<b>AgSnO<sub>2</sub> + 0.2 μm Au</b>

## Delay-on energisation

### PZA

Electrical data	
External contact fuse protection ( $I_K = 1 \text{ kA}$ ) to <b>EN 60947-5-1</b>	
Blow-out fuse, quick	
Safety contacts:	<b>6 A</b>
Auxiliary contacts:	<b>6 A</b>
Blow-out fuse, slow	
Safety contacts:	<b>4 A</b>
Auxiliary contacts:	<b>4 A</b>
Circuit breaker 24 VAC/DC, characteristic B/C	
Safety contacts:	<b>4 A</b>
Auxiliary contacts:	<b>4 A</b>
Times	
Delay-on de-energisation	<b>40 ms</b>
Recovery time at max. switching frequency 1/s after power failure	
	<b>80 ms</b>
Delay time $t_V$ : selectable	<b>30,00 s; 40,00 s; 50,00 s; 70,00 s; 90,00 s; 120,00 s; 150,00 s; 180,00 s; 210,00 s; 240,00 s; 270,00 s; 300,00 s</b> Order no.: 774020
	<b>30,00 s; 40,00 s; 50,00 s; 70,00 s; 90,00 s; 120,00 s; 150,00 s; 180,00 s; 210,00 s; 240,00 s; 270,00 s; 300,00 s</b> Order no.: 774021
	<b>30,00 s; 40,00 s; 50,00 s; 70,00 s; 90,00 s; 120,00 s; 150,00 s; 180,00 s; 210,00 s; 240,00 s; 270,00 s; 300,00 s</b> Order no.: 774023
	<b>30,00 s; 40,00 s; 50,00 s; 70,00 s; 90,00 s; 120,00 s; 150,00 s; 180,00 s; 210,00 s; 240,00 s; 270,00 s; 300,00 s</b> Order no.: 774026
	<b>60,00 s; 80,00 s; 100,00 s; 140,00 s; 180,00 s; 240,00 s; 300,00 s; 360,00 s; 420,00 s; 480,00 s; 540,00 s; 600,00 s</b> Order no.: 774028
	<b>30,00 s; 40,00 s; 50,00 s; 70,00 s; 90,00 s; 120,00 s; 150,00 s; 180,00 s; 210,00 s; 240,00 s; 270,00 s; 300,00 s</b> Order no.: 774029
	<b>3,00 s; 4,00 s; 5,00 s; 7,00 s; 9,00 s; 12,00 s; 15,00 s; 18,00 s; 21,00 s; 24,00 s; 27,00 s; 30,00 s</b> Order no.: 774030
	<b>3,00 s; 4,00 s; 5,00 s; 7,00 s; 9,00 s; 12,00 s; 15,00 s; 18,00 s; 21,00 s; 24,00 s; 27,00 s; 30,00 s</b> Order no.: 774031
	<b>3,00 s; 4,00 s; 5,00 s; 7,00 s; 9,00 s; 12,00 s; 15,00 s; 18,00 s; 21,00 s; 24,00 s; 27,00 s; 30,00 s</b> Order no.: 774035
	<b>0,30 s; 0,40 s; 0,50 s; 0,70 s; 0,90 s; 1,20 s; 1,50 s; 1,80 s; 2,10 s; 2,40 s; 2,70 s; 3,00 s</b> Order no.: 774038
	<b>3,00 s; 4,00 s; 5,00 s; 7,00 s; 9,00 s; 12,00 s; 15,00 s; 18,00 s; 21,00 s; 24,00 s; 27,00 s; 30,00 s</b> Order no.: 774040
	<b>0,30 s; 0,40 s; 0,50 s; 0,70 s; 0,90 s; 1,20 s; 1,50 s; 1,80 s; 2,10 s; 2,40 s; 2,70 s; 3,00 s</b> Order no.: 774041
Repetition accuracy	<b>1 %</b>
Environmental data	
EMC	<b>EN 60947-5-1, EN 61000-6-2</b>
Vibration to <b>EN 60068-2-6</b>	
Frequency	<b>10 - 55 Hz</b>
Amplitude	<b>0.35 mm</b>
Climatic suitability	<b>EN 60068-2-78</b>
Airgap creepage in accordance with <b>EN 60947-1</b>	
Ambient temperature	<b>-10 - 55 °C</b>
Storage temperature	<b>-40 - 85 °C</b>
Protection type	
Mounting (e.g. cabinet)	<b>IP54</b>
Housing	<b>IP40</b>
Terminals	<b>IP20</b>

## Delay-on energisation PZA

Mechanical data	
Housing material	
Housing	<b>PPO UL 94 V0</b>
Front	<b>ABS UL 94 V0</b>
Cross section of external conductors with screw terminals	
1 core flexible	<b>0.20 - 4.00 mm<sup>2</sup> , 24 - 10 AWG</b>
2 core, same cross section, flexible:	
with crimp connectors, without insulating sleeve	<b>0.20 - 2.50 mm<sup>2</sup> , 24 - 14 AWG</b>
without crimp connectors or with TWIN crimp connectors	<b>0.20 - 2.50 mm<sup>2</sup> , 24 - 14 AWG</b>
Torque setting with screw terminals	<b>0.60 Nm</b>
Dimensions	
Height	<b>87.0 mm</b>
Width	<b>45.0 mm</b>
Depth	<b>121.0 mm</b>
Weight	<b>260 g</b> Order no.: 774028, 774029, 774030, 774041 <b>350 g</b> Order no.: 774020, 774021, 774023, 774026, 774031, 774035, 774038, 774040

The standards current on **04/04** apply.

Order reference			
Type	Features	Terminals	Order no.
PZA	24 VAC	300 s selectable Screw terminals	774 020
PZA	42 VAC	300 s selectable Screw terminals	774 021
PZA	110 - 120 VAC	300 s selectable Screw terminals	774 023
PZA	230 VAC	300 s selectable Screw terminals	774 026
PZA		24 VDC 600 s selectable Screw terminals	774 028
PZA		24 VDC 300 s selectable Screw terminals	774 029
PZA		24 VDC 30 s selectable Screw terminals	774 030
PZA	24 VAC	30 s selectable Screw terminals	774 031
PZA	110 - 120 VAC	30 s selectable Screw terminals	774 035
PZA	230 VAC	3 s selectable Screw terminals	774 038
PZA	230 VAC	30 s selectable Screw terminals	774 040
PZA		24 VDC 3 s selectable Screw terminals	774 041