

uniclip ltd

HOSE CLIPS

100 Royston Road
Byfleet Surrey KT14 7NY England
Telephone: (01932) 355277
Fax: (01932) 351285

Our ref: PEC/dl/1186

10 October 1997

Mr Shaun Smith
Product Buyer.
RS Components Limited
PO Box 99 Corby
Northamptonshire
NN17 9RS.

Dear Shaun,

Ref. :New Product Enquiry, MR 32340/0247 - UNEX high performance Hose Clips.

Further to our telephone conversation earlier this morning concerning the material specification of our UNEX hose clips.

We can confirm that our clips are manufactured in the following materials :

UNEX type D - standard material : Brass CZ131 screw and bush, stainless steel band in 304S 31 (1.4401) AISI 316 Low Mo and stainless steel saddle in 304S 15 (1.4301) AISI 304.

UNEX type H - standard material: Brass CZ131 screw and bush, stainless band in 304S 31 (1.4401) AISI 316 Low Mo and stainless steel saddle and hexagonal cap in 304S 15 (1.4301) AISI 304.

We have also enclosed copies of our drawings for both types for your records.

Trusting the above and enclosed meets with your approval, if you require any further assistance please do not hesitate to contact us.

Yours sincerely,
For and on behalf of Uniclip Limited.,

R. Debbie Lynn

W.E. Shepherd.
Managing Director.

Drng No. UNX-D01

Drng No. UNX-D01

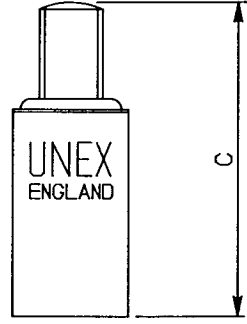
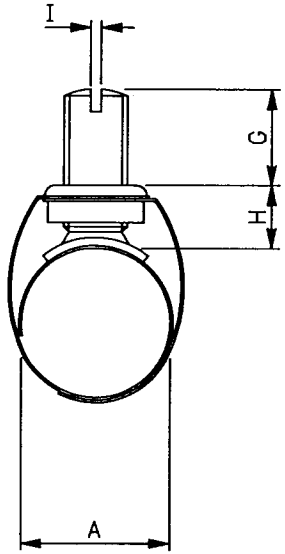
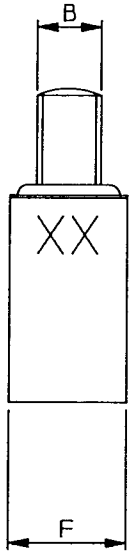
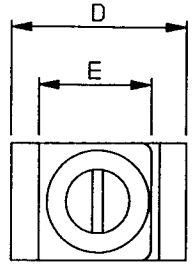

SIZE XX	A		B	C		D Max	E	F	G		H		I
	Min	Max		Min	Max				Min	Max	Min	Max	
10	7.4	10.0	0 BA	22	27	14	11	11	0	12	4	16	1.0
12	9.0	12.0	0 BA	25	29	15	11	11	0	12	4	16	1.0
14	9.6	14.0	0 BA	25	29	16	11	11	0	17	4	21	1.0
17	12.2	17.0	0 BA	33	40	19	11	11	0	17	4	21	1.0
19	14.0	19.0	0 BA	36	43	21	11	11	0	17	4	21	1.0
21	15.5	21.0	0 BA	38	44	22	11	11	0	17	5	22	1.0
22	17.3	22.0	0 BA	39	45	24	11	11	0	17	5	22	1.0
25	19.8	25.0	0 BA	42	49	26	11	11	0	17	5	22	1.0
27	21.8	27.0	0 BA	46	53	27	11	11	0	20	5	25	1.0
30	25.0	30.0	0 BA	49	57	31	11	11	0	20	5	25	1.0
33	27.7	33.0	0 BA	52	60	33	11	11	0	20	5	25	1.0
35	30.0	35.0	0 BA	54	62	35	11	11	0	20	5	25	1.0
38	33.0	38.0	0 BA	58	67	38	11	11	0	20	5	25	1.0
41	35.3	41.0	0 BA	62	70	41	11	11	0	20	5	25	1.0

Drawn CEB	Approved <i>[Signature]</i>	Mat'l N/A	Title D TYPE UNEX HOSE CLIP SIZE CHART					
Scale 2:1	Drng size A3	DO NOT SCALE 	Mat'l Spec N/A	Issue 1	DCN No. / Modification --	Date 14.11.95	Checked	
First used on	Mat'l Size N/A	Finish N/A	Part No. N/A	Issue	DCN No. / Modification	Date	Checked	
UNICLIP LTD ROYSTON ROAD, BYFLEET, SURREY.								

ALL DIMENSIONS IN MILLIMETRES
UNLESS OTHERWISE STATED

Drng No.
UNX-D01

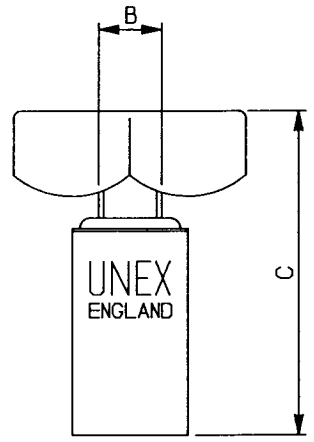
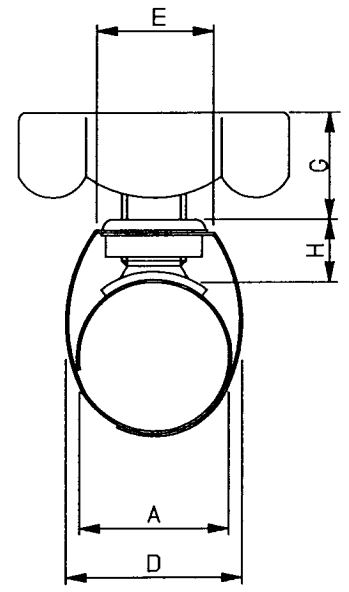
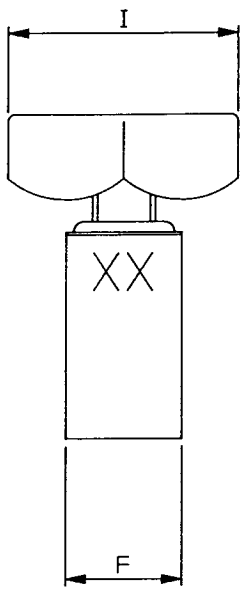
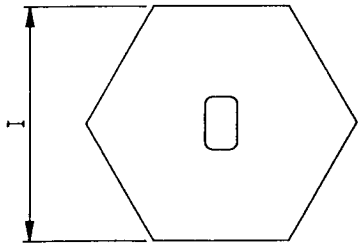

SIZE XX	A		B	C		D	E	F	G		H		I
	Min	Max		Min	Max				Min	Max	Min	Max	
10	7.4	10.0	0 BA	22	27	14	11	11	1	13	4	16	22
12	9.0	12.0	0 BA	25	29	15	11	11	1	13	4	16	22
14	9.6	14.0	0 BA	25	29	16	11	11	1	18	4	21	22
17	12.2	17.0	0 BA	33	40	19	11	11	1	18	4	21	22
19	14.0	19.0	0 BA	36	43	21	11	11	1	18	4	21	22
21	15.5	21.0	0 BA	38	44	22	11	11	1	18	5	22	22
22	17.3	22.0	0 BA	39	45	24	11	11	1	18	5	22	22
25	19.8	25.0	0 BA	42	49	26	11	11	1	18	5	22	22
27	21.8	27.0	0 BA	46	53	27	11	11	1	21	5	25	22
30	25.0	30.0	0 BA	49	57	31	11	11	1	21	5	25	22
33	27.7	33.0	0 BA	52	60	33	11	11	1	21	5	25	22
35	30.0	35.0	0 BA	54	62	35	11	11	1	21	5	25	22
38	33.0	38.0	0 BA	58	67	38	11	11	1	21	5	25	22
41	35.3	41.0	0 BA	62	70	41	11	11	1	21	5	25	22

Drawn CEB	Approved 	Mat'l N/A	Title H TYPE UNEX HOSE CLIP SIZE CHART								
Scale 2:1	Drng size A3	DO NOT SCALE 	Mat'l Spec N/A	Issue	DCN No. / Modification	Date	Checked	Issue	DCN No. / Modification	Date	Checked
First used on			Mat'l Size N/A	1	--	14.11.95					
UNICLIP LTD ROYSTON ROAD, BYFLEET, SURREY.			Finish N/A								
			Part No. N/A								

ALL DIMENSIONS IN MILLIMETRES UNLESS OTHERWISE STATED